

TTA Standard

정보통신단체표준(기술규격)
TTAT.3G-29.531(R15-15.0.0)

제정일: 2018년 9월

3GPP-(Technical Speciation
Group Core Network and
Terminals; 5G System; Network
Slice Selection Services; Stage 3)



본 문서에 대한 저작권은 TTA에 있으며, TTA와 사전 협의 없이 이 문서의 전체 또는 일부를 상업적 목적으로 복제 또는 배포해서는 안 됩니다.

Copyright 20xx, Telecommunications Technology Association.
All rights reserved.

3GPP TS 29.531 V15.0.0 (2018-06)

Technical Specification

**3rd Generation Partnership Project;
Technical Specification Group Core Network and Terminals;
5G System;
Network Slice Selection Services;
Stage 3
(Release 15)**



Keywords

3GPP, 5G System

3GPP

Postal address

3GPP support office address

650 Route des Lucioles - Sophia Antipolis
Valbonne - FRANCE
Tel.: +33 4 92 94 42 00 Fax: +33 4 93 65 47 16

Internet

<http://www.3gpp.org>

Copyright Notification

No part may be reproduced except as authorized by written permission.
The copyright and the foregoing restriction extend to reproduction in all media.

© 2018, 3GPP Organizational Partners (ARIB, ATIS, CCSA, ETSI, TSDSI, TTA, TTC).
All rights reserved.

UMTS™ is a Trade Mark of ETSI registered for the benefit of its members
3GPP™ is a Trade Mark of ETSI registered for the benefit of its Members and of the 3GPP Organizational Partners
LTE™ is a Trade Mark of ETSI registered for the benefit of its Members and of the 3GPP Organizational Partners
GSM® and the GSM logo are registered and owned by the GSM Association

Contents

Foreword	6
1 Scope	6
2 References	6
3 Definitions and abbreviations	7
3.1 Definitions	7
3.2 Abbreviations	7
4 Overview	7
4.1 Introduction	7
5 Services offered by the NSSF	8
5.1 Introduction	8
5.2 Nnssf_NSSelection Service	8
5.2.1 Service Description	8
5.2.2 Service Operations	8
5.2.2.1 Introduction	8
5.2.2.2 GET	8
5.2.2.2.1 General	8
5.2.2.2.2 Get service operation of Nnssf_NSSelection service during the registration procedure	9
5.2.2.2.3 Get service operation of Nnssf_NSSelection service during the PDU session establishment	9
5.3 Nnssf_NSSAIAvailability Service	10
5.3.1 Service Description	10
5.3.2 Service Operations	10
5.3.2.1 Introduction	10
5.3.2.2 Update Service Operation	11
5.3.2.2.1 General	11
5.3.2.3 Subscribe Service Operation	11
5.3.2.3.1 General	11
5.3.2.4 Unsubscribe Service Operation	12
5.3.2.4.1 General	12
5.3.2.5 Notify Service Operation	12
5.3.2.5.1 General	12
5.3.2.6 Delete Service Operation	13
5.3.2.6.1 General	13
6 API Definitions	13
6.1 Nnssf_NSSelection Service API	13
6.1.1 API URI	13
6.1.2 Usage of HTTP	14
6.1.2.1 General	14
6.1.2.2 HTTP standard headers	14
6.1.2.2.1 General	14
6.1.2.2.2 Content type	14
6.1.2.3 HTTP custom headers	14
6.1.2.3.1 General	14
6.1.3 Resources	14
6.1.3.1 Overview	14
6.1.3.2 Resource: Network Slice Information Document	15
6.1.3.2.1 Description	15
6.1.3.2.2 Resource Definition	15
6.1.3.2.3 Resource Standard Methods	15
6.1.3.2.3.1 GET	15
6.1.3.2.4 Resource Custom Operations	16
6.1.4 Custom Operations without associated resources	16
6.1.5 Notifications	17
6.1.6 Data Model	17

6.1.6.1	General	17
6.1.6.2	Structured data types	17
6.1.6.2.1	Introduction.....	17
6.1.6.2.2	Type: AuthorizedNetworkSliceInfo.....	18
6.1.6.2.3	Type: SubscribedSNssai	18
6.1.6.2.4	Type: SubscribedNssai.....	18
6.1.6.2.5	Type: AllowedSNssai	19
6.1.6.2.6	Type: AllowedNssai.....	19
6.1.6.2.7	Type: NsiInformation.....	19
6.1.6.2.8	Type: MappingOfRequestedSNssai	19
6.1.6.2.9	Type: MappingOfRequestedNssai	19
6.1.6.2.10	Type: SliceInfoForRegistration.....	20
6.1.6.2.11	Type: SliceInfoForPDUSession	20
6.1.6.2.12	Type: ConfiguredSnsai	20
6.1.6.2.13	Type: ConfiguredNssai	20
6.1.6.3	Simple data types and enumerations.....	21
6.1.6.3.1	Introduction.....	21
6.1.6.3.2	Simple data types	21
6.1.6.3.3	Enumeration: RoamingIndication	21
6.1.6.4	Binary data	21
6.1.7	Error Handling	21
6.1.7.1	General	21
6.1.7.2	Protocol Errors.....	21
6.1.7.3	Application Errors	21
6.1.8	Feature negotiation.....	22
6.1.9	Security	22
6.2	Nssf_NSSAIAvailability Service API	22
6.2.1	API URI.....	22
6.2.2	Usage of HTTP	22
6.2.2.1	General	22
6.2.2.2	HTTP standard headers	23
6.2.2.2.1	General.....	23
6.2.2.2.2	Content type.....	23
6.2.2.3	HTTP custom headers	23
6.2.2.3.1	General.....	23
6.2.3	Resources	23
6.2.3.1	Overview	23
6.2.3.2	Resource: NSSAI Availability Store	24
6.2.3.2.1	Description.....	24
6.2.3.2.2	Resource Definition	24
6.2.3.2.3	Resource Standard Methods.....	24
6.2.3.2.3.1	PUT	24
6.2.3.2.3.2	PATCH.....	25
6.2.3.2.3.3	DELETE.....	26
6.2.3.3	Resource: NSSAI Availability Notification Subscriptions Collection	26
6.2.3.3.1	Description.....	26
6.2.3.3.2	Resource Definition	26
6.2.3.3.3	Resource Standard Methods.....	26
6.2.3.3.3.1	POST	26
6.2.3.4	Resource: Individual NSSAI Availability Notification Subscriptions.....	27
6.2.3.4.1	Description.....	27
6.2.3.4.2	Resource Definition	27
6.2.3.4.3	Resource Standard Methods.....	27
6.2.3.4.3.1	DELETE.....	27
6.2.4	Custom Operations without associated resources	28
6.2.5	Notifications	28
6.2.5.1	General	28
6.2.5.2	NSSAI Availability Notification	28
6.2.5.2.1	Description.....	28
6.2.5.2.2	Notification Definition.....	28
6.2.5.2.3	Notification Standard Methods	28
6.2.5.2.3.1	POST	28

6.2.6	Data Model.....	29
6.2.6.1	General	29
6.2.6.2	Structured data types	29
6.2.6.2.1	Introduction.....	29
6.2.6.2.2	Type: NssaiAvailabilityInfo.....	30
6.2.6.2.3	Type: SupportedNssaiAvailabilityData	30
6.2.6.2.4	Type: AuthorizedNssaiAvailabilityData	30
6.2.6.2.5	Type: RestrictedSnssai.....	30
6.2.6.2.6	Type: AuthorizedNssaiAvailabilityinfo	31
6.2.6.2.7	Type: PatchDocument.....	31
6.2.6.2.8	Type: NssfEventSubscriptionCreateData.....	31
6.2.6.2.9	Type: NssfEventSubscriptionCreatedData.....	31
6.2.6.2.10	Type: NssfEventNotification	32
6.2.6.3	Simple data types and enumerations.....	32
6.2.6.3.1	Introduction.....	32
6.2.6.3.2	Simple data types	32
6.2.6.3.3	Enumeration: NssfEventType.....	32
6.2.6.4	Binary data	32
6.2.7	Error Handling	32
6.2.7.1	General	32
6.2.7.2	Protocol Errors.....	32
6.2.7.3	Application Errors	33
6.2.8	Feature negotiation.....	33
6.2.9	Security	33
Annex A (normative):		
	OpenAPI specification.....	34
A.1	General.....	34
A.2	Nssf_NSSelection API.....	34
A.3	Nssf_NSSAIAvailability API.....	37
Annex B (informative):		
	Change history	43

Foreword

This Technical Specification has been produced by the 3rd Generation Partnership Project (3GPP).

The contents of the present document are subject to continuing work within the TSG and may change following formal TSG approval. Should the TSG modify the contents of the present document, it will be re-released by the TSG with an identifying change of release date and an increase in version number as follows:

Version x.y.z

where:

- x the first digit:
 - 1 presented to TSG for information;
 - 2 presented to TSG for approval;
 - 3 or greater indicates TSG approved document under change control.
- y the second digit is incremented for all changes of substance, i.e. technical enhancements, corrections, updates, etc.
- z the third digit is incremented when editorial only changes have been incorporated in the document.

1 Scope

The present document specifies the stage 3 protocol and data model for the Nnssf Service Based Interface. It provides stage 3 protocol definitions and message flows, and specifies the API for each service offered by the NSSF.

The 5G System stage 2 architecture and procedures are specified in 3GPP TS 23.501 [2] and 3GPP TS 23.502 [3].

The Technical Realization of the Service Based Architecture and the Principles and Guidelines for Services Definition are specified in 3GPP TS 29.500 [4] and 3GPP TS 29.501 [5].

2 References

The following documents contain provisions which, through reference in this text, constitute provisions of the present document.

- References are either specific (identified by date of publication, edition number, version number, etc.) or non-specific.
- For a specific reference, subsequent revisions do not apply.
- For a non-specific reference, the latest version applies. In the case of a reference to a 3GPP document (including a GSM document), a non-specific reference implicitly refers to the latest version of that document *in the same Release as the present document*.

- [1] 3GPP TR 21.905: "Vocabulary for 3GPP Specifications".
- [2] 3GPP TS 23.501: "System Architecture for the 5G System; Stage 2".
- [3] 3GPP TS 23.502: "Procedures for the 5G System; Stage 2".
- [4] 3GPP TS 29.500: "5G System; Technical Realization of Service Based Architecture; Stage 3".
- [5] 3GPP TS 29.501: "5G System; Principles and Guidelines for Services Definition; Stage 3".

- [6] OpenAPI: "OpenAPI 3.0.0 Specification", <https://github.com/OAI/OpenAPI-Specification/blob/master/versions/3.0.0.md>.
- [7] 3GPP TS 29.571: "5G System; Common Data Types for Service Based Interfaces; Stage 3".
- [8] IETF RFC 6902: "JavaScript Object Notation (JSON) Patch".
- [9] 3GPP TS 23.003: "Numbering, addressing and identification".
- [10] IETF RFC 7540: "Hypertext Transfer Protocol Version 2 (HTTP/2)".
- [11] 3GPP TS 33.501: "Security architecture and procedures for 5G system".
- [12] IETF RFC 6749: "The OAuth 2.0 Authorization Framework".
- [13] 3GPP TS 29.510: "Network Function Repository Services; Stage 3".

3 Definitions and abbreviations

3.1 Definitions

For the purposes of the present document, the terms and definitions given in 3GPP TR 21.905 [1] and the following apply. A term defined in the present document takes precedence over the definition of the same term, if any, in 3GPP TR 21.905 [1].

3.2 Abbreviations

For the purposes of the present document, the abbreviations given in 3GPP TR 21.905 [1] and the following apply. An abbreviation defined in the present document takes precedence over the definition of the same abbreviation, if any, in 3GPP TR 21.905 [1].

4 Overview

4.1 Introduction

Within the 5GC, the NSSF offers services to the AMF and NSSF in a different PLMN via the Nnssf service based interface (see 3GPP TS 23.501 [2] and 3GPP TS 23.502 [3]).

Figure 4.1-1 provides the reference model (in service based interface representation and in reference point representation), with focus on the NSSF and the scope of the present specification.

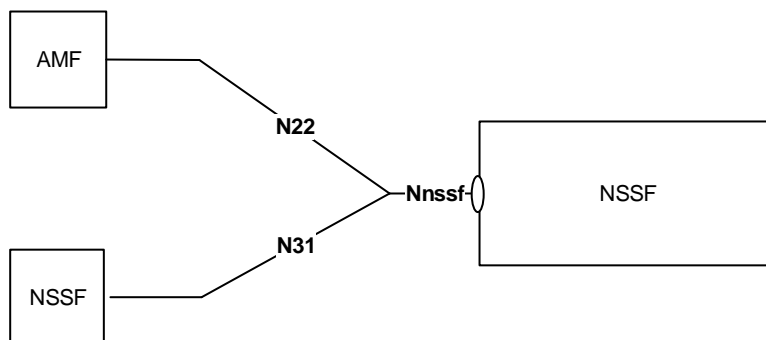

Figure 4.1-1: NSSF in 5G System architecture

The functionalities supported by the NSSF are listed in subclause 6.2.14 of 3GPP TS 23.501 [2].

5 Services offered by the NSSF

5.1 Introduction

The NSSF supports the following services.

Table 5.1-1: NF Services provided by NSSF

Service Name	Description	Example Consumer
Nnssf_NSSelection	This service enables Network Slice selection in both the Serving PLMN and the HPLMN	AMF, V-NSSF
Nnssf_NSSAIAvailability	This service enables to update the S-NSSAI(s) the AMF supports on a per TA basis on the NSSF and update the restricted S-NSSAI(s) per TA and per PLMN on the AMF.	AMF

5.2 Nnssf_NSSelection Service

5.2.1 Service Description

The Nnssf_NSSelection service is used by an NF Service Consumer (e.g. AMF or NSSF in a different PLMN) to retrieve the information related to network slice in the non-roaming and roaming case. It also enables the NSSF to provide to the AMF the Allowed NSSAI and the Configured NSSAI for the Serving PLMN. The NF service consumer discovers the NSSF based on the local configuration. The NSSF in a different PLMN is discovered based on the self-constructed FQDN as specified in 3GPP TS 23.003[9].

5.2.2 Service Operations

5.2.2.1 Introduction

For the Nnssf_NSSelection service the following service operations are defined:

- Get.

5.2.2.2 GET

5.2.2.2.1 General

The Get operation shall be used in the non-roaming or roaming scenario to retrieve:

- The Allowed NSSAI, Configured NSSAI, target AMF Set or the list of candidate AMF(s), and optionally
 - The Mapping Of Allowed NSSAI;
 - The Mapping Of Configured NSSAI;
 - NSI ID(s) associated with the Network Slice instances of the Allowed NSSAI;
 - NRF(s) to be used to select NFs/services within the selected Network Slice instance(s) and NRF to be used to determine the list of candidate AMF(s) from the AMF Set, during Registration procedure and
 - Information on whether the S-NSSAI(s) not included in the Allowed NSSAI which were part of the Requested NSSAI are rejected in the serving PLMN or in the current TA.
- The NRF to be used to select NFs/services within the selected network slice instance, and optionally the NSI ID associated with the S-NSSAI provided in the input, during the PDU Session Establishment procedure.

It is used in the following procedures:

- Registration with AMF re-allocation (see subclause 4.2.2.2.3 of 3GPP TS 23.502 [3]);
- UE Configuration Update procedure (see subclause 4.2.4.2 of 3GPP TS 23.502 [3]);
- SMF selection for non-roaming and roaming with local breakout (see subclause 4.3.2.2.3.2 of 3GPP TS 23.502 [3]) or SMF selection for home-routed roaming scenario (see subclause 4.3.2.2.3.3 of 3GPP TS 23.502 [3]).

NOTE: The list of procedures above, which trigger invoking of the Nnssf_NSSelection_Get service operation, is not exhaustive.

5.2.2.2.2 Get service operation of Nnssf_NSSelection service during the registration procedure

In this procedure, the NF Service Consumer (e.g. AMF) retrieves the Allowed NSSAI, Configured NSSAI, target AMF Set or the list of candidate AMF(s) and other optional information.

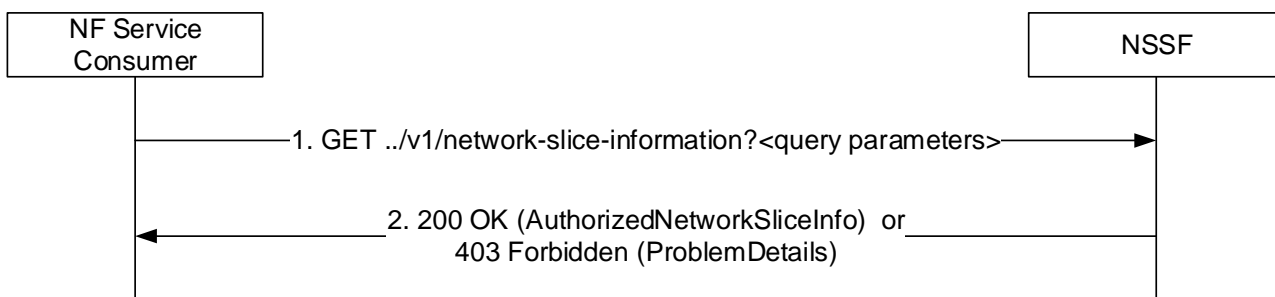

Figure 5.2.2.2.2-1: Retrieve the network slice information during the registration procedure

- 1 The AMF shall send a GET request to the NSSF. One or more of the following parameters shall be included as query parameters: Requested NSSAI, Subscribed S-NSSAI(s) with the indication if marked as default S-NSSAI, PLMN ID of the SUPI, TAI, NF type of the NF service consumer, Requester ID.
- 2 On success, "200 OK" shall be returned in the following cases:
 - When the NSSF is able to find authorized network slice information for the requested network slice selection information, the response body shall include a payload body containing at least the Allowed NSSAI, target AMF Set or the list of candidate AMF(s);
 - If no slice instances can be found for the requested slice selection information, then the response body shall contain an empty "AuthorizedNetworkSliceInfo" JSON object.

On failure, the NSSF shall return one of the HTTP status codes together with the response body listed in Table 6.1.3.2.3.1-3.

5.2.2.2.3 Get service operation of Nnssf_NSSelection service during the PDU session establishment

In this procedure, the NF Service Consumer (e.g. AMF) retrieves the NRF and the optionally the NSI ID of the network slice instance:

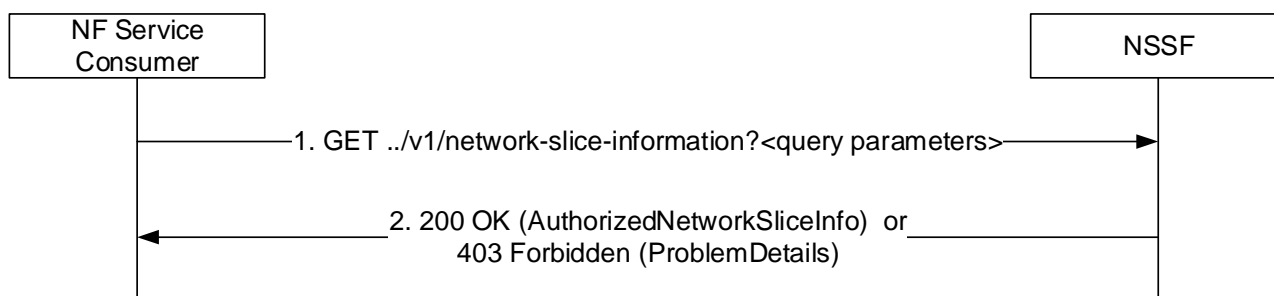

Figure 5.2.2.2.3-1: Retrieve the network slice information during the PDU session establishment procedure

- 1 The NF Service consumer (e.g. AMF or NSSF in the different PLMN) shall send a GET request to the NSSF. The request shall include query parameters, contain at least S-NSSAI, S-NSSAI from the Configured NSSAI for the HPLMN that maps to the S-NSSAI from the Allowed NSSAI of the Serving PLMN, the NF type of the NF service consumer and Requester ID. For the procedure invoked in the Serving PLMN, the query parameters shall also contain non-roaming/LBO roaming/HR roaming indication, PLMN ID of the SUPI and TAI.
- 2 On success, "200 OK" shall be returned in the following cases:
 - When the NSSF is able to find network slice instance information for the requested network slice selection information, the response body shall include a payload body containing at least the NRF to be used to select NFs/services within the selected Network Slice instance;
 - If no slice instances can be found for the requested slice selection information, then the response body shall contain an empty "AuthorizedNetworkSliceInfo" JSON object.

On failure, the NSSF shall return one of the HTTP status codes together with the response body listed in Table 6.1.3.2.3.1-3.

5.3 Nnssf_NSSAIAvailability Service

5.3.1 Service Description

The Nnssf_NSSAIAvailability service is used by the AMF to update the S-NSSAI(s) the AMF supports on a per TA basis on the NSSF, subscribe and unsubscribe the notification of any changes to the NSSAI availability information and used by the NSSF to update the restricted S-NSSAI(s) per TA and per PLMN on the AMF.

5.3.2 Service Operations

5.3.2.1 Introduction

For the Nnssf_NSSAIAvailability service the following service operations are defined:

- Update;
- Subscribe;
- Unsubscribe;
- Notify.

5.3.2.2 Update Service Operation

5.3.2.2.1 General

The Update operation shall be used by an NF Service Consumer (e.g. AMF) to update the NSSF with the S-NSSAIs the NF service consumer (e.g. AMF) supports per TA, and get the availability of the S-NSSAIs per TA for the S-NSSAIs the NF service consumer (e.g. AMF) supports.

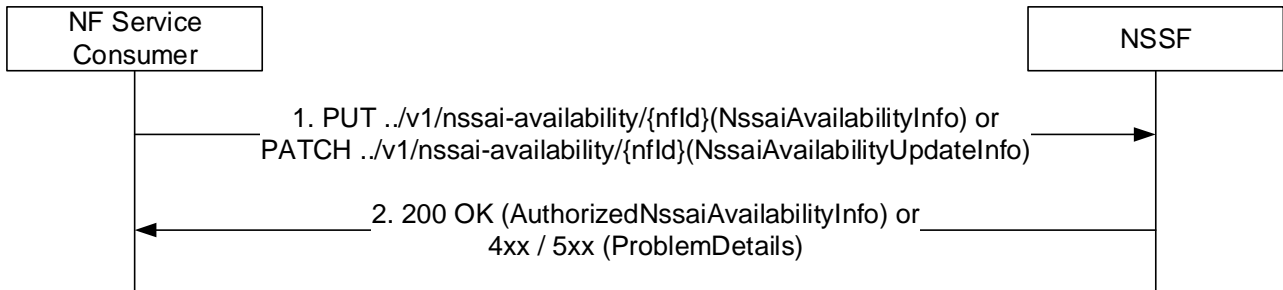

Figure 5.3.2.2.1-1: Update the S-NSSAIs the AMF supports per TA

1. The NF service consumer (e.g. AMF) shall send a PUT request to the resource representing the NSSAI Availability information of the individual NF, identified by the {nfId}, to replace or create the NSSAI Availability information of the NF. The payload of the body shall contain the NssaiAvailabilityInfo which contains one or more representations of the individual supportedSnsai information to be replaced.

The NF service consumer (e.g. AMF) shall send a PATCH request to the resource representing the NSSAI Availability information of the individual NF, identified by the {nfId}, to update the NSSAI Availability information of the NF. The payload of the body shall contain the PatchDocument which contains one or more PatchItem instructions for updating the individual supportedSnsai resources.

2. On success, "200 OK" shall be returned, the payload body of the PUT/PATCH response shall contain the representation describing the status of the request and the complete AuthorizedNssaiAvailabilityData information representing the current state of the AuthorizedNssaiAvailabilityInfo.

On failure, the NSSF shall return one of the HTTP status code together with the response body listed in Table 6.2.3.2.3.1-2 / Table 6.2.3.2.3.2-2.

5.3.2.3 Subscribe Service Operation

5.3.2.3.1 General

The Subscribe Operation is used by a NF Service Consumer (e.g. AMF) to subscribe to a notification of any changes to the NSSAI availability information (e.g. the restricted S-NSSAI(s) per TA and per PLMN on the AMF) upon this is updated by another AMF.

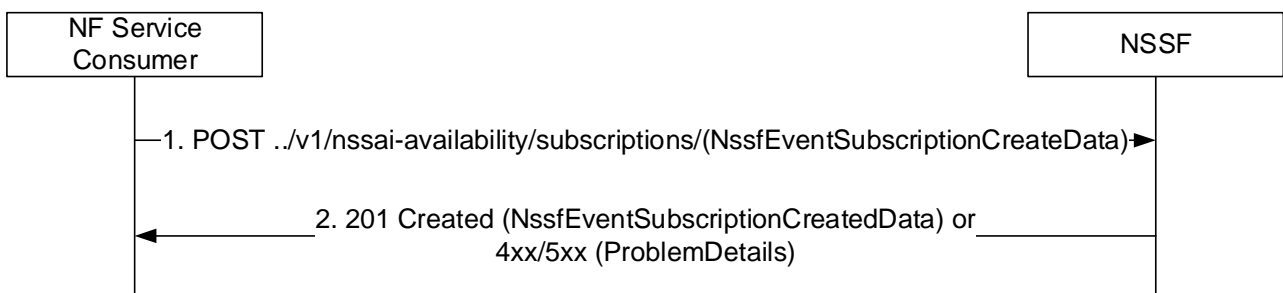

Figure 5.3.2.3.1-1 Create a subscription

1. The NF Service Consumer shall send a POST request to create a subscription resource in the NSSF. The payload body of the POST request shall contain a representation of the individual event subscription resource to be created in the NssfEventSubscriptionCreateData.

2. On success, "201 Created" shall be returned, and the payload body of the POST response shall contain the representation describing the status of the created subscription in NssfEventSubscriptionCreatedData that may contain the AuthorizedNssaiAvailabilityData information, if available. The Location header shall contain the location (URI) of the created subscription resource.

On failure, the NSSF shall return one of the HTTP status code together with the response body listed in Table 6.2.3.3.3.1-2.

5.3.2.4 Unsubscribe Service Operation

5.3.2.4.1 General

The Unsubscribe Operation is used by a NF Service Consumer (e.g. AMF) to unsubscribe to a notification of any changes to the NSSAI availability information (e.g. the restricted S-NSSAI(s) per TA and per PLMN on the AMF) upon this is updated by another AMF.

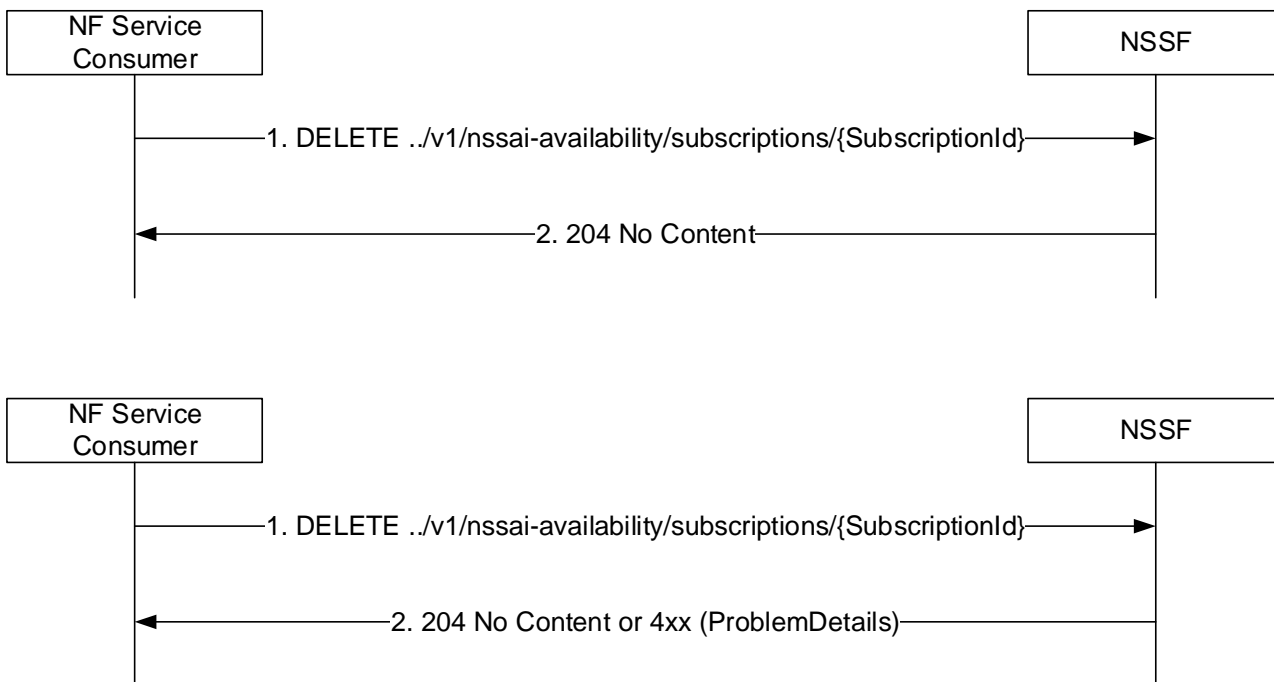

Figure 5.3.2.4.1-1 Unsubscribe a subscription

1. The NF Service Consumer shall send a DELETE request to delete an existing subscription resource in the NSSF.
2. If the request is accepted, the NSSF shall respond with the status code 204 indicating the resource identified by subscription ID is successfully deleted.

On failure, the NSSF shall return one of the HTTP status code together with the response body listed in Table 6.2.3.4.3.2-2.

5.3.2.5 Notify Service Operation

5.3.2.5.1 General

The Notify Service operation shall be used by the NSSF to update the NF Service Consumer (e.g. AMF) with any S-NSSAIs restricted per TA and per PLMN in the serving PLMN of the UE.

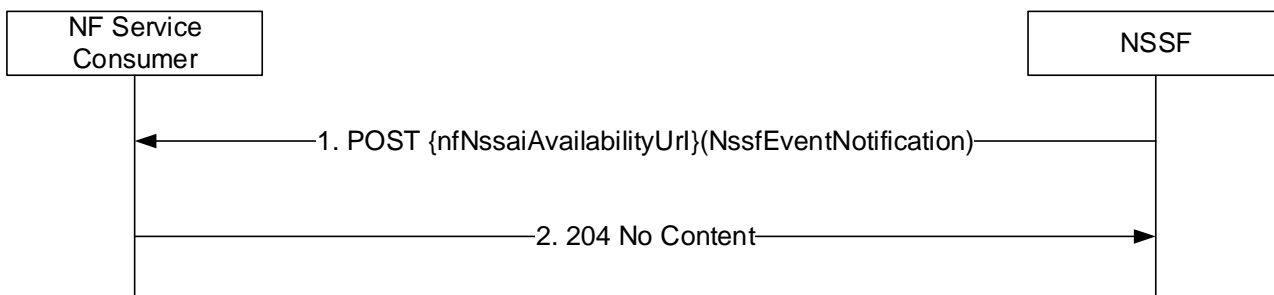

Figure 5.3.2.5.1-1: Update the AMF with any S-NSSAIs restricted per TA

1. The NSSF shall send a POST request to the resource representing the NSSF availability resource in the NF service consumer (e.g. AMF). The payload body of the POST request shall contain the one representations of the individual NssfEventNotificationresource.
2. On success, "204 No Content" shall be returned and the payload body of the POST response shall be empty.

5.3.2.6 Delete Service Operation

5.3.2.6.1 General

The Delete Service operation shall be used by the NF service consumer (e.g. AMF) to delete the NSSAI availability information stored for the NF service consumer in the NSSF.

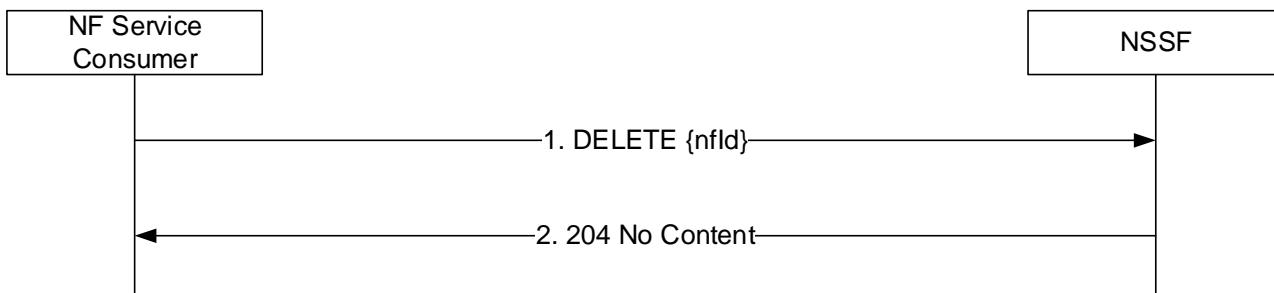

Figure 5.3.2.6.1-1: Delete the NSSAI Availability Information at NSSF

1. The NF service consumer (e.g. AMF) shall send a DELETE request to remove the NSSAI availability information for the NF service consumer represented by the {nfId} (e.g. AMF ID).
2. The NSSF shall delete the NSSAI Availability information for the individual AMF and shall return the 204 No Content status code.

6 API Definitions

6.1 Nssf_NSSelection Service API

6.1.1 API URI

URIs of this API shall have the following root:

```
{apiRoot}/{apiName}/{apiVersion}/
```

where the "apiName" shall be set to "nssf-nselection" and the "apiVersion" shall be set to "v1" for the current version of this specification.

6.1.2 Usage of HTTP

6.1.2.1 General

HTTP/2, IETF RFC 7540 [10], shall be used as specified in clause 5 of 3GPP TS 29.500 [4].

An OpenAPI [6] specification of HTTP messages and content bodies for the Nnssf_NSSelection service is specified in Annex A.

6.1.2.2 HTTP standard headers

6.1.2.2.1 General

See subclause 5.2.2 of 3GPP TS 29.500 [4] for the usage of HTTP standard headers.

6.1.2.2.2 Content type

The JSON format shall be supported. The use of JSON format shall be as specified in sub-clause 5.4 of 3GPP TS 29.500 [4].

6.1.2.3 HTTP custom headers

6.1.2.3.1 General

In this release of this specification, no custom headers specific to the Nnssf_NSSelection service are defined. For 3GPP specific HTTP custom headers used across all service based interfaces, see clause 5.2.3 of 3GPP TS 29.500 [4].

6.1.3 Resources

6.1.3.1 Overview

Figure 6.1.3.1-1 describes the resource URI structure of the Nnssf_NSSelection API.

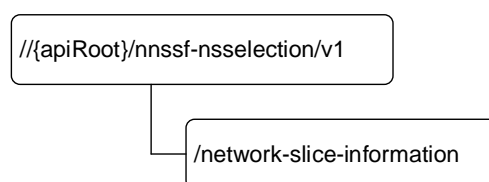

Figure 6.1.3.1-1: Resource URI structure of the nnssf_nssselection API

Table 6.1.3.1-1 provides an overview of the resources and applicable HTTP methods.

Table 6.1.3.1-1: Resources and methods overview

Resource name	Resource URI	HTTP method or custom operation	Description
Network Slice Related Information	://{apiRoot}/nssf-nselection/v1/network-slice-information	GET	To retrieve network slice information. See subclause 6.1.3.2.3.1. Maps to Nssf_NSSelection_Get service operation.

6.1.3.2 Resource: Network Slice Information Document

6.1.3.2.1 Description

This resource represents the network slice related information maintained by the NSSF. This resource is modelled with the Document resource archetype (see subclause C.1 of 3GPP TS 29.501 [5]).

6.1.3.2.2 Resource Definition

Resource URI:://{apiRoot}/nssf-nselection/v1/network-slice-information

This resource shall support the resource URI variables defined in table 6.1.3.2.2-1.

Table 6.1.3.2.2-1: Resource URI variables for this resource

Name	Definition
apiRoot	See subclause 6.1.1

6.1.3.2.3 Resource Standard Methods

6.1.3.2.3.1 GET

This method retrieves the information related to the selected slice based on the input query parameters provided by the NF service consumer specified in table 6.1.3.2.3.1-1.

This method shall support input query parameters specified in table 6.1.3.2.3.1-1 and the response data structure and response codes specified in table 6.1.3.2.3.1-3.

Table 6.1.3.2.3.1-1: URI query parameters supported by the GET method on this resource

Name	Data type	P	Cardinality	Description
nf-type	NfType	M	1	This IE shall contain the NF type of the NF service consumer.
nf-id	NfInstanceId	M	1	This IE shall contain the NF identifier of the NF service consumer.
slice-info-request-for-registration	SliceInfoForRegistration	C	0..1	This IE shall be present when the network slice information is requested during the Registration procedure towards an NSSF in the serving PLMN.
slice-info-request-for-pdu-session	SliceInfoForPDUSession	C	0..1	This IE shall be present when the network slice information is requested during the PDU session establishment procedure.
home-plmn-id	PlmnId	C	0..1	This IE shall be present in the request towards an NSSF in the serving PLMN if the subscriber is a roamer to the serving PLMN. When present, this IE shall contain the home PLMN Id of the UE.
tai	Tai	C	0..1	This IE shall be present in the request towards an NSSF in the serving PLMN. When present, this IE shall contain the TAI the UE is currently located.
supported-features	SupportedFeatures	C	0..1	This IE shall be present if at least one optional feature defined in subclause 6.1.8 is supported.

Table 6.1.3.2.3.1-2: Data structures supported by the GET Request Body on this resource

Data type	P	Cardinality	Description
n/a			

Table 6.1.3.2.3.1-3: Data structures supported by the GET Response Body on this resource

Data type	P	Cardinality	Response codes	Description
AuthorizedNetworkSliceInfo	M	1	200 OK	This case represents a successful return of the authorized network slice information selected for the corresponding request.
ProblemDetails	M	1	403 Forbidden	This represents the case, where the NF service consumer is not authorized to retrieve the slice selection information or the SNSSAI included in the requested slice selection information is not supported in the PLMN. The application specific error information shall be provided in the "cause" attribute. The "cause" attribute shall be set to: <ul style="list-style-type: none"> - "SNSSAI_NOT_SUPPORTED", if the SNSSAI included in the requested slice selection information is not supported in the PLMN.

6.1.3.2.4 Resource Custom Operations

There are no custom methods supported on the network-slice-information collection resource.

6.1.4 Custom Operations without associated resources

There are no custom operations without associated resources defined for the Nnssf_NSSelection service in this version of this API.

6.1.5 Notifications

In this release of this specification, there are no notifications defined for the Nnssf_NSSelection service.

6.1.6 Data Model

6.1.6.1 General

This subclause specifies the application data model supported by the API.

Table 6.1.6.1-1 specifies the data types defined for the Nnssf service based interface protocol.

Table 6.1.6.1-1: Nnssf_NSSelection specific Data Types

Data type	Section defined	Description
AuthorizedNetworkSliceInfo	6.1.6.2.2	Contains the authorized network slice information.
SubscribedSNssai	6.1.6.2.3	Contains the subscribed S-NSSAI.
SubscribedNssai	6.1.6.2.4	Contains an array of subscribed S-NSSAI that constitute the subscribed NSSAI information.
AllowedSNssai	6.1.6.2.5	Contains the authorized S-NSSAI and optional mapped home S-NSSAI and network slice instance information.
AllowedNssai	6.1.6.2.6	Contains an array of allowed S-NSSAI that constitute the allowed NSSAI information for the authorized network slice information.
NsiInformation	6.1.6.2.7	Contains the identifier of NRF to be used to select NFs/services within the selected Network Slice instance and optional the Identifier of the selected Network Slice instance.
MappingOfRequestedSNssai	6.1.6.2.8	Contains the mapping of requested S-NSSAI in the serving network and the value of the home network.
MappingOfRequestedNssai	6.1.6.2.9	Contains an array of the requested S-NSSAI mapping.
SliceInfoForRegistration	6.1.6.2.10	Contains the slice information requested during a Registration procedure.
SliceInfoForPDUSession	6.1.6.2.11	Contains the slice information requested during PDU Session establishment procedure.
ConfiguredSnssai	6.1.6.2.12	Contains the configured S-NSSAI(s) authorized by the NSSF in the serving PLMN and optional mapped home S-NSSAI.
ConfiguredNssai	6.1.6.2.13	Contains an array of the configured S-NSSAI(s) authorized by the NSSF in the serving PLMN

Table 6.1.6.1-2 specifies data types re-used by the Nnssf. service based interface protocol from other specifications, including a reference to their respective specifications and when needed, a short description of their use within the Nnssf service based interface.

Table 6.1.6.1-2: Nnssf re-used Data Types

Data type	Reference	Comments
SupportedFeatures	3GPP TS 29.571 [7]	Used to negotiate the applicability of the optional features defined in table 6.1.8-1.

6.1.6.2 Structured data types

6.1.6.2.1 Introduction

This subclause defines the structures to be used in resource representations.

Allowed structures are: array, object.

6.1.6.2.2 Type: AuthorizedNetworkSliceInfo

Table 6.1.6.2.2-1: Definition of type AuthorizedNetworkSliceInfo

Attribute name	Data type	P	Cardinality	Description
allowedNssai	AllowedNssai	C	1	This IE shall contain the allowed S-NSSAI(s) authorized by the NSSF in the serving PLMN, if the NSSF received the Requested NSSAI and the subscribed S-NSSAI(s).
configuredNssai	ConfiguredNssai	C	1	This IE shall contain the configured S-NSSAI(s) authorized by the NSSF in the serving PLMN, if the NSSF did not receive any Requested NSSAI or the Requested NSSAI includes an S-NSSAI that is not valid in the Serving PLMN.
targetAmfSet	string	O	0..1	This IE may be included by the NSSF based on configuration and if the NSSF received the Requested NSSAI and the subscribed S-NSSAI(s). When present, this IE shall contain the target AMF set.
candidateAmf	array(NfInstanceId)	O	0..N	This IE may be included by the NSSF based on configuration and if the NSSF received the Requested NSSAI and the subscribed S-NSSAI(s). When present, this IE shall contain the list of candidate AMF(s).
rejectedNssaiInPlmn	array(Snssai)	O	0..N	This IE may be included by the NSSF if the NSSF received the Requested NSSAI and the subscribed S-NSSAI(s). When present, this IE shall contain the rejected NSSAI in the PLMN.
rejectedNssaiInTa	array(Snssai)	O	0..N	This IE may be included by the NSSF if the NSSF received the Requested NSSAI and the subscribed S-NSSAI(s). When present, this IE shall contain the rejected NSSAI in the current TA.
nsiInformation	NsiInformation	C	0..1	This IE shall be included by the NSSF if the NSSF received the S-NSSAI. (i.e. during PDU session establishment procedure)
supportedFeatures	SupportedFeatures	C	0..1	This IE shall be present if at least one optional feature defined in subclause 6.1.8 is supported

6.1.6.2.3 Type: SubscribedSNssai

Table 6.1.6.2.3-1: Definition of type SubscribedSNssai

Attribute name	Data type	P	Cardinality	Description
subscribedSNssai	SNssai	M	1	This IE shall contain the subscribed S-NSSAI.
defaultIndication	boolean	O	0..1	If it is set, the subscribed S-NSSAI is a default subscribed S-NSSAI.

6.1.6.2.4 Type: SubscribedNssai

Table 6.1.6.2.4-1: Definition of type SubscribedNssai

Attribute name	Data type	P	Cardinality	Description
subscribedSNssai	array(SubscribedSNssai)	M	1..N	This IE shall contain the list of subscribed S-NSSAIs.

6.1.6.2.5 Type: AllowedSNssai

Table 6.1.6.2.5-1: Definition of type AllowedSNssai

Attribute name	Data type	P	Cardinality	Description
allowedSNssai	SNssai	M	1	This IE shall contain the allowed S-NSSAI in the serving PLMN.
nsiInformation	array(NsiInformation)	O	0..N	If present, this IE shall include the information related to the network slice instance corresponding to the allowed S-NSSAI.
mappedHomeSNssai	SNssai	O	1	When present, this IE shall contain the mapped S-NSSAI value of home network corresponding to the allowed S-NSSAI in the serving PLMN.

6.1.6.2.6 Type: AllowedNssai

Table 6.1.6.2.6-1: Definition of type AllowedNssai

Attribute name	Data type	P	Cardinality	Description
allowedSNssai	array(AllowedSNssai)	M	1..N	This IE shall contain the allowed S-NSSAI in the serving PLMN.

6.1.6.2.7 Type: NsiInformation

Table 6.1.6.2.7-1: Definition of type NsiInformation

Attribute name	Data type	P	Cardinality	Description
nrfId	Fqdn	M	0..1	This IE shall contain the identifier of NRF to be used to select NFs/services within the selected Network Slice instance.
nsiId	NsiId	O	0..1	This IE may be optionally included by the NSSF. When present, this IE shall contain the Identifier of the selected Network Slice instance

6.1.6.2.8 Type: MappingOfRequestedSNssai

Table 6.1.6.2.8-1: Definition of type MappingOfRequestedSNssai

Attribute name	Data type	P	Cardinality	Description
servingSNssai	SNssai	M	1	This IE shall contain the S-NSSAI value of serving network.
homeSNssai	SNssai	M	1	This IE shall contain the mapped S-NSSAI value of home network.

6.1.6.2.9 Type: MappingOfRequestedNssai

Table 6.1.6.2.9-1: Definition of type MappingOfRequestedNssai

Attribute name	Data type	P	Cardinality	Description
mappingOfRequestedSNssai	array(MappingOfRequestedSNssai)	M	1..N	This IE shall contain the mapping of S-NSSAI value of serving network to the corresponding S-NSSAI value of the home network.

6.1.6.2.10 Type: SliceInfoForRegistration

Table 6.1.6.2.10-1: Definition of type SliceInfoForRegistration

Attribute name	Data type	P	Cardinality	Description
subscribedNSSAI	SubscribedNssai	M	1	This IE shall contain the list of subscribed S-NSSAIs along with an indication for each S-NSSAI if it is a default S-NSSAI, if available.
mappingOfRequestedSNssai	MappingOfRequestedNssai	O	0..1	This IE may be present when the network slice information is requested during the Registration procedure. If present, this IE shall contain the Mapping Of Requested NSSAI.
requestedNssai	array(Snssai)	O	0..N	This IE may contain the set of S-NSSAIs requested by the UE.

6.1.6.2.11 Type: SliceInfoForPDUSession

Table 6.1.6.2.11-1: Definition of type SliceInfoForPDUSession

Attribute name	Data type	P	Cardinality	Description
sNssai	SNssai	M	1	This IE shall contain the requested S-NSSAI for the PDU session. when the AMF queries the NSSF in the serving PLMN. When the vNSSF queries the hNSSF during PDU session establishment for home routed roaming case, this IE shall contain the S-NSSAI from the Configured NSSAI for the HPLMN that maps to the S-NSSAI from the Allowed NSSAI of the Serving PLMN, as obtained from the NF Service Consumer of the vNSSF.
roamingIndication	RoamingIndication	M	1	This IE shall contain the indication whether the UE is in non-roaming, LBO roaming or HR roaming.
homeSNssai	Snssai	C	1	This IE shall be included by the NF Service Consumer (e.g. AMF) towards the vNSSF during PDU session establishment procedure in home routed roaming scenario. This IE shall contain the S-NSSAI from the Configured NSSAI for the HPLMN that maps to the S-NSSAI from the Allowed NSSAI of the Serving PLMN when the UE in the roaming scenario.

6.1.6.2.12 Type: ConfiguredSnssai

Table 6.1.6.2.12-1: Definition of type ConfiguredSNssai

Attribute name	Data type	P	Cardinality	Description
configuredSnssai	Snssai	M	1	This IE shall contain the configured S-NSSAI in the serving PLMN.
mappedHomeSnssai	Snssai	O	1	When present, this IE shall contain the mapped S-NSSAI value of home network corresponding to the configured S-NSSAI in the serving PLMN.

6.1.6.2.13 Type: ConfiguredNssai

Table 6.1.6.2.13-1: Definition of type ConfiguredNssai

Attribute name	Data type	P	Cardinality	Description
configuredSnssai	array(ConfiguredSnssai)	M	1..N	This IE shall contain the configured S-NSSAI in the serving PLMN.

6.1.6.3 Simple data types and enumerations

6.1.6.3.1 Introduction

This subclause defines simple data types and enumerations that can be referenced from data structures defined in the previous subclauses.

6.1.6.3.2 Simple data types

The simple data types defined in table 6.1.6.3.2-1 shall be supported.

Table 6.1.6.3.2-1: Simple data types

Type Name	Type Definition	Description
Nsild	string	Represents the Network Slice Instance Identifier

6.1.6.3.3 Enumeration: RoamingIndication

Table 6.1.6.3.3-1: Enumeration RoamingIndication

Enumeration value	Description
NON_ROAMING	This value indicates that the UE is not roaming.
LOCAL_BREAKOUT	This value indicates that the UE is roaming but is using a local breakout PDU session.
HOME_ROUTED_ROAMING	This value indicates that the UE is roaming and is using a home routed PDU session.

6.1.6.4 Binary data

There is no binary data used for the Nnsf_NSSelection service in this version of the API.

6.1.7 Error Handling

6.1.7.1 General

HTTP error handling shall be supported as specified in subclause 5.2.4 of 3GPP TS 29.500 [4].

6.1.7.2 Protocol Errors

Protocol Error Handling shall be supported as specified in subclause 5.2.7.2 of 3GPP TS 29.500 [4].

6.1.7.3 Application Errors

The common application errors defined in the Table 5.2.7.2-1 in 3GPP TS 29.500 [4] may also be used for the Nnsf_NSSelection service. The following application errors listed in Table 6.1.7.3-1 are specific for the Nnsf_NSSelection service.

Table 6.1.7.3-1: Application errors

Application Error	HTTP status code	Description
SNSSAI_NOT_SUPPORTED	403 Forbidden	This cause value shall be set when the requested slice selection information is for SNSSAI(s) not supported in the PLMN.

6.1.8 Feature negotiation

The feature negotiation mechanism specified in subclause 6.6 of 3GPP TS 29.500 [4] shall be used to negotiate the optional features applicable between the NSSF and the NF Service Consumer, for the Nnssf_NSSelection service, if any.

The NF Service Consumer shall indicate the optional features it supports for the Nnssf_NSSelection service, if any, by including the supportedFeatures attribute in the HTTP POST request when requesting the NSSF to provide the allowed NSSAI information.

The NSSF shall determine the supported features for the requested network slice information resource as specified in subclause 6.6 of 3GPP TS 29.500 [4] and shall indicate the supported features by including the supportedFeatures attribute in the allowed NSSAI information it returns in the HTTP response.

The syntax of the supportedFeatures attribute is defined in subclause 5.2.2 of 3GPP TS 29.571 [5].

The following features are defined for the Nnssf_NSSelection service.

Table 6.1.8-1: Features of supportedFeatures attribute used by Nnssf_NSSelection service

Feature Number	Feature	M/O	Description
Feature number: The order number of the feature within the supportedFeatures attribute (starting with 1). Feature: A short name that can be used to refer to the bit and to the feature. M/O: Defines if the implementation of the feature is mandatory ("M") or optional ("O"). Description: A clear textual description of the feature.			

6.1.9 Security

As indicated in 3GPP TS 33.501 [11], the access to the Nnssf_NSSelection API shall be authorized by means of the OAuth2 protocol (see IETF RFC 6749 [12]), using the "Client Credentials" authorization grant, where the NRF (see 3GPP TS 29.510 [13]) plays the role of the authorization server.

An NF Service Consumer, prior to consuming services offered by the Nnssf_NSSelection API, shall obtain a "token" from the authorization server, by invoking the Access Token Request service, as described in 3GPP TS 29.510 [13], subclause 5.4.2.2.

NOTE: When multiple NRFs are deployed in a network, the NRF used as authorization server is the same NRF that the NF Service Consumer used for discovering the Nnssf_NSSelection service.

The Nnssf_NSSelection API does not define any scopes for OAuth2 authorization.

6.2 Nnssf_NSSAIAvailability Service API

6.2.1 API URI

URIs of this API shall have the following root:

```
{apiRoot}/{apiName}/{apiVersion}/
```

where the "apiName" shall be set to "nssf-nssaiavailability" and the "apiVersion" shall be set to "v1" for the current version of this specification.

6.2.2 Usage of HTTP

6.2.2.1 General

HTTP/2, IETF RFC 7540 [10], shall be used as specified in clause 5 of 3GPP TS 29.500 [4].

An OpenAPI [6] specification of HTTP messages and content bodies for the Nnssf_NSSAIAvailability service is specified in Annex A.

6.2.2.2 HTTP standard headers

6.2.2.2.1 General

See subclause 5.2.2 of 3GPP TS 29.500 [4] for the usage of HTTP standard headers.

6.2.2.2.2 Content type

The JSON format shall be supported. The use of JSON format shall be as specified in sub-clause 5.4 of 3GPP TS 29.500 [4].

6.2.2.3 HTTP custom headers

6.2.2.3.1 General

In this release of this specification, no custom headers specific to the Nnssf_NSSAIAvailability service are defined. For 3GPP specific HTTP custom headers used across all service based interfaces, see clause 5.2.3 of 3GPP TS 29.500 [4].

6.2.3 Resources

6.2.3.1 Overview

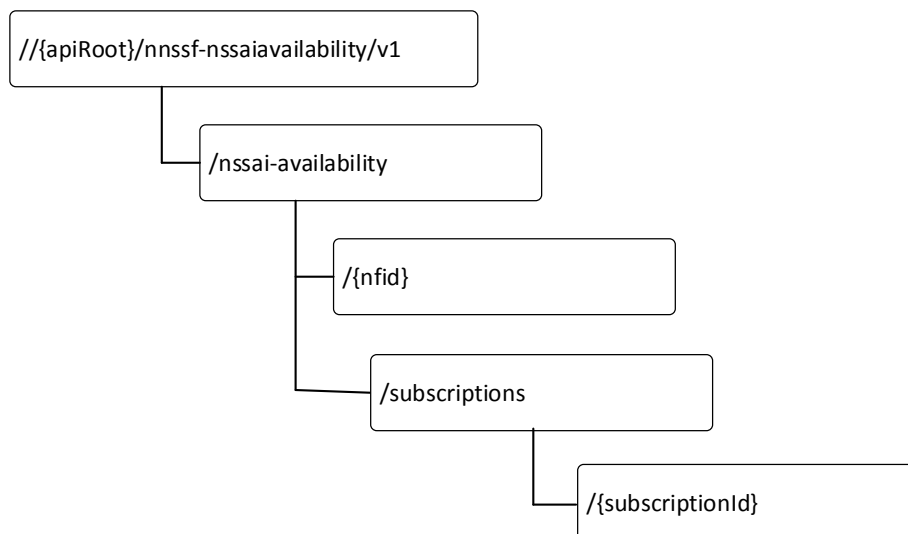

Figure 6.2.3.1-1: Resource URI structure of the Nnssf_NSSAIAvailability API

Table 6.2.3.1-1 provides an overview of the resources and applicable HTTP methods.

Table 6.2.3.1-1: Resources and methods overview

Resource name	Resource URI	HTTP method or custom operation	Description
NSSAI Availability Store	://{apiRoot}/nssf-nssaiavailability/v1/nssai-availability/{nflId}	PUT	Updates the NSSF with the S-NSSAIs the NF service consumer (e.g. AMF) supports per TA.
		PATCH	Updates the NSSF with the S-NSSAIs the NF service consumer (e.g. AMF) supports per TA.
		DELETE	Delete the resource of the S-NSSAIs supported per TA by the NF service consumer (e.g. AMF)
NSSAI Availability Notification Subscriptions Collection	://{apiRoot}/nssf-nssaiavailability/v1/nssai-availability/subscriptions	POST	Create a subscription to the notification of any changes to the NSSAI availability information.
Individual NSSAI Availability Notification Subscriptions	://{apiRoot}/nssf-nssaiavailability/v1/nssai-availability/subscriptions/{subscriptionId}	DELETE	Unsubscribe to the notification of any changes to the NSSAI availability information.

6.2.3.2 Resource: NSSAI Availability Store

6.2.3.2.1 Description

This resource represents a collection of NSSAI Availability resources generated by the NSSF.

This resource is modelled with the Store resource archetype (see subclause C.1 of 3GPP TS 29.501 [5]).

6.2.3.2.2 Resource Definition

Resource URI:://{apiRoot}/nssf-nssaiavailability/v1/nssai-availability/{nflId}

This resource shall support the resource URI variables defined in table 6.2.3.2.2-1.

Table 6.2.3.2.2-1: Resource URI variables for this resource

Name	Definition
apiRoot	See subclause 6.2.1
nflId	Represents the Identifier of the AMF for which the NSSAI Availability information is updated.

6.2.3.2.3 Resource Standard Methods

6.2.3.2.3.1 PUT

This method shall support the request data structures specified in table 6.2.3.2.3.1-1 and the response data structures and response codes specified in table 6.2.3.2.3.1-2.

Table 6.2.3.2.3.1-1: Data structures supported by the PUT Request Body on this resource

Data type	P	Cardinality	Description
NSSAIAvailabilityInfo	M	1	This IE contains the information regarding the NssaiAvailabilityData for the AMF and/or the corresponding notification URL for the NSSF to notify any changes to the NSSAI availability information.

Table 6.2.3.2.3.1-2: Data structures supported by the PUT Response Body on this resource

Data type	P	Cardinality	Response codes	Description
AuthorizedNssaiAvailabilityInfo	M	1	200 OK	This case represents a successful update of the NSSF with the S-NSSAIs the AMF supports per TA. The authorized NSSAI availability (i.e. any S-NSSAIs restricted per TA and per PLMN in the serving PLMN of the UE) information shall be returned in the response payload body.
ProblemDetails	M	1	403 Forbidden	This represents the case, when the NF service consumer is not authorized to update the NSSAI availability information or the TAI/SNSSAI information provided is not supported in the PLMN. The "cause" attribute shall be set to: - "SNSSAI_NOT_SUPPORTED", if the SNSSAI provided is not supported in the PLMN.
ProblemDetails	M	1	404 Not Found	This represents the case when the resource related to the NF Id for which the NSSAI availability information is updated is unavailable.

6.2.3.2.3.2 PATCH

This method shall support the request data structures specified in table 6.2.3.2.3.2-1 and the response data structures and response codes specified in table 6.2.3.2.3.2-2.

Table 6.2.3.2.3.2-1: Data structures supported by the PATCH Request Body on this resource

Data type	P	Cardinality	Description
PatchDocument	M	1	This IE contains the information regarding the JSON patch instructions for updating the AuthorizedNssaiAvailabilityInfo.

Table 6.2.3.2.3.2-2: Data structures supported by the PATCH Response Body on this resource

Data type	P	Cardinality	Response codes	Description
AuthorizedNssaiAvailabilityInfo	M	1	200 OK	This case represents a successful update of the NSSF with the S-NSSAIs the AMF supports per TA. If the authorized NSSAI availability (i.e. any S-NSSAIs restricted per TA and per PLMN in the serving PLMN of the UE) is changed, the NSSF shall return a data structure of type "AuthorizedNssaiAvailabilityInfo" in the response payload body.
ProblemDetails	M	1	403 Forbidden	This represents the case, when the NF service consumer is not authorized to update the NSSAI availability information or the SNSSAI information provided is not supported in the PLMN. The "cause" attribute shall be set to: - "SNSSAI_NOT_SUPPORTED", if the SNSSAI provided is not supported in the PLMN.
ProblemDetails	M	1	404 Not Found	This represents the case when the resource related to the NF Id for which the NSSAI availability information is updated is unavailable.

6.2.3.2.3.3 DELETE

This method shall support the request data structures specified in table 6.2.3.2.3.3-1 and the response data structures and response codes specified in table 6.2.3.2.3.3-2.

Table 6.2.3.2.3.3-1: Data structures supported by the DELETE Request Body on this resource

Data type	P	Cardinality	Description
n/a			

Table 6.2.3.2.3.3-2: Data structures supported by the DELETE Response Body on this resource

Data type	P	Cardinality	Response codes	Description
n/a			204 No Content	
ProblemDetails	M	1	404 Not Found	This represents the case when the resource related to the NF Id for which the NSSAI availability information is updated is unavailable.

6.2.3.3 Resource: NSSAI Availability Notification Subscriptions Collection

6.2.3.3.1 Description

This resource represents the collection of NSSAI Availability Notification Subscriptions in the NSSF.

This resource is modelled with the Collection resource archetype (see subclause C.2 of 3GPP TS 29.501 [5]).

6.2.3.3.2 Resource Definition

Resource URI: `://{apiRoot}/nssf-nssaiavailability/v1/nssai-availability/subscriptions`

This resource shall support the resource URI variables defined in table 6.2.3.3.2-1.

Table 6.2.3.3.2-1: Resource URI variables for this resource

Name	Definition
apiRoot	See subclause 6.2.1

6.2.3.3.3 Resource Standard Methods

6.2.3.3.3.1 POST

This method shall support the request data structures specified in table 6.2.3.3.3.1-1 and the response data structures and response codes specified in table 6.2.3.3.3.1-2.

Table 6.2.3.3.3.1-1: Data structures supported by the POST Request Body on this resource

Data type	P	Cardinality	Description
NssfEventSubscriptionCreateData	M	1	This IE contains the information regarding the SubscriptionData for the AMF to notify any changes to the NSSAI availability information.

Table 6.2.3.3.1-2: Data structures supported by the POST Response Body on this resource

Data type	P	Cardinality	Response codes	Description
NssfEventSubscriptionCreatedData	M	1	201 Created	This case represents a successful creation of subscription to the change of NSSAI availability information.
ProblemDetails	M	1	403 Forbidden	This represents the case, when the NF service consumer is not authorized to subscribe for the NSSAI availability information notification.
ProblemDetails	M	1	404 Not Found	This represents the case when the subscriptions collection resource does not exist at the NSSF..

6.2.3.4 Resource: Individual NSSAI Availability Notification Subscriptions

6.2.3.4.1 Description

This resource represents an Individual NSSAI Availability Notification Subscriptions resources generated by the NSSF.

This resource is modelled with the Document resource archetype (see subclause C.1 of 3GPP TS 29.501 [5]).

6.2.3.4.2 Resource Definition

Resource URI: `://{apiRoot}/nssf-nssaiavailability/v1/nssai-availability/subscriptions/{subscriptionId}`

This resource shall support the resource URI variables defined in table 6.2.3.4.2-1.

Table 6.2.3.3.2-1: Resource URI variables for this resource

Name	Definition
apiRoot	See subclause 6.2.1
subscriptionId	Represents the Identifier of the subscription.

6.2.3.4.3 Resource Standard Methods

6.2.3.4.3.1 DELETE

This method shall support the request data structures specified in table 6.2.3.4.3.2-1 and the response data structures and response codes specified in table 6.2.3.4.3.2-2.

Table 6.2.3.3.2-1: Data structures supported by the DELETE Request Body on this resource

Data type	P	Cardinality	Description
N/A			

Table 6.2.3.4.3.2-2: Data structures supported by the DELETE Response Body on this resource

Data type	P	Cardinality	Response codes	Description
N/A			204 NO Content	This case represents a successful deletion of the subscription.
ProblemDetails	M	1	404 Not Found	This represents the case when the subscription resource is unavailable.

6.2.4 Custom Operations without associated resources

There are no custom operations without associated resources for the Nnssf_NSSAIAvailability service in this version of the API.

6.2.5 Notifications

6.2.5.1 General

This subclause specifies the notifications provided by the Nnssf_NSSAIAvailability service.

6.2.5.2 NSSAI Availability Notification

6.2.5.2.1 Description

If the NF Service Consumer (e.g. AMF) has provided the callback URI for getting notified about the NSSAI availability information, the NSSF shall notify the NF Service Consumer whenever the NSSAI availability information is updated.

6.2.5.2.2 Notification Definition

Resource URI: {amfNssaiAvailabilityUri}

This resource URI is provided by the NF Service Consumer (e.g. AMF) during NSSAI Availability Information update invoked by the NF Service Consumer.

Table 6.2.5.2.2-1: Resources and methods overview

Resource name	Resource URI	HTTP method or custom operation	Description
NSSAI Availability Notification Callback	{nfNssaiAvailabilityUri}	POST	The NSSF uses this callback URI to Update the AMF with any S-NSSAIs restricted per TA in the serving PLMN of the UE.

6.2.5.2.3 Notification Standard Methods

6.2.5.2.3.1 POST

This method shall support the request data structures specified in table 6.2.5.2.3.1-1 and the response data structures and response codes specified in table 6.2.5.2.3.1-2.

Table 6.2.5.2.3.1-1: Data structures supported by the POST Request Body on this resource

Data type	P	Cardinality	Description
NssfEventNotification	M	1	Representation of the data to be sent to the NF service consumer (e.g. AMF) to update NSSAI availability information, authorized by the NSSF in the serving PLMN.

Table 6.2.5.2.3.1-2: Data structures supported by the POST Response Body on this resource

Data type	P	Cardinality	Response codes	Description
n/a			204 No Content	This case represents a successful update of the NF service consumer (e.g. AMF) with NSSAI availability information.

6.2.6 Data Model

6.2.6.1 General

This subclause specifies the application data model supported by the API.

Table 6.2.6.1-1 specifies the data types defined for the Nnssf_NSSAIAvailability service based interface protocol.

Table 6.2.6.1-1: Nnssf_NSSAIAvailability specific Data Types

Data type	Section defined	Description
NSSAIAvailabilityInfo	6.2.6.2.2	This contains the Nssai availability information requested by the AMF.
SupportedNssaiAvailabilityData	6.2.6.2.3	This contains the Nssai availability data information per TA supported by the AMF.
AuthorizedNssaiAvailabilityData	6.2.6.2.4	This contains the Nssai availability data information per TA authorized by the NSSF
RestrictedSnssai	6.2.6.2.5	This contains the restricted SNssai information per PLMN.
AuthorizedNssaiAvailabilityInfo	6.2.6.2.6	This contains the Nssai availability data information authorized by the NSSF
PatchDocument	6.2.6.2.7	This contains the JSON Patch instructions for updating the Nssai availability data information at the NSSF.
NssfEventSubscriptionCreateData	6.2.6.2.8	This contains the information for event subscription.
NssfEventSubscriptionCreatedData	6.2.6.2.9	This contains the information for event subscription.
NssfEventNotification	6.2.6.2.10	This contains the information for created event subscription.

Table 6.2.6.1-2 specifies data types re-used by the Nnssf service based interface protocol from other specifications, including a reference to their respective specifications and when needed, a short description of their use within the N_{<NF>} service based interface.

Table 6.2.6.1-2: Nnssf-re-used Data Types

Data type	Reference	Comments
SupportedFeatures	3GPP TS 29.571 [7]	Used to negotiate the applicability of the optional features defined in table 6.2.8-1.
Snssai	3GPP TS 29.571 [7]	
PatchItem	3GPP TS 29.571 [7]	Identifies the JSON Patch instructions

6.2.6.2 Structured data types

6.2.6.2.1 Introduction

This subclause defines the structures to be used in resource representations.

Allowed structures are: array, object.

6.2.6.2.2 Type: NssaiAvailabilityInfo

Table 6.2.6.2.2-1: Definition of type NssaiAvailabilityInfo

Attribute name	Data type	P	Cardinality	Description
supportedNssaiAvailabilityData	SupportedNssaiAvailabilityData	M	1..N	This IE shall contain the information regarding the S-NSSAIs the NF service consumer (e.g. AMF) supports per TA.
nfNssaiAvailabilityUri	Uri	O	0..1	This IE may be included by the NF service consumer (e.g. AMF) for the NSSF to notify any change of NSSAI availability information.
supportedFeatures	SupportedFeatures	C	0..1	This IE shall be present if at least one optional feature defined in subclause 6.2.8 is supported

6.2.6.2.3 Type: SupportedNssaiAvailabilityData

Table 6.2.6.2.3-1: Definition of type SupportedNssaiAvailabilityData

Attribute name	Data type	P	Cardinality	Description
tai	Tai	M	1	This IE shall contain the identifier of the Tracking Area
supportedSNssai	array(SNssai)	M	1..N	This IE shall contain the S-NSSAI(s) supported by the AMF for the TA.

6.2.6.2.4 Type: AuthorizedNssaiAvailabilityData

Table 6.2.6.2.4-1: Definition of type AuthorizedNssaiAvailabilityData

Attribute name	Data type	P	Cardinality	Description
tai	Tai	M	1	This IE shall contain the identifier of the Tracking Area.
supportedSnssai	array(Snssai)	M	1..N	This IE shall contain the SNSSAI(s) supported by the AMF for the TA.
restrictedSnssai	RestrictedSnssai	O	0..N	This IE may contain the restricted S-NSSAI(s) per PLMN for the TA. If the restricted SNssai is not present, no restricted S-NSSAI is applicable to the TA. When present, this IE shall be included only by the NSSF.

6.2.6.2.5 Type: RestrictedSnssai

Table 6.2.6.2.5-1: Definition of type RestrictedSNssai

Attribute name	Data type	P	Cardinality	Description
homePlmnId	PlmnId	M	1	This IE shall contain the home PLMN ID of the PLMN with which the serving network has roaming agreement.
sNssai	array(Snssai)	M	1..N	This IE shall contain the array of restricted S-NSSAIs for the home PLMN Id.

6.2.6.2.6 Type: AuthorizedNssaiAvailabilityInfo

Table 6.2.6.2.6 -1: Definition of type AuthorizedNssaiAvailabilityInfo

Attribute name	Data type	P	Cardinality	Description
authorizedNssaiAvailabilityData	array(AuthorizedNssaiAvailabilityData)	M	1..N	Contains the authorized NSSAI availability information.
nfNssaiAvailabilityUri	Uri	O	0..1	This IE may be included by the NSSF if the NF service consumer (e.g. AMF) of the NSSF has included this IE in the NssaiAvailabilityInfo sent in the request.
supportedFeatures	SupportedFeatures	C	0..1	This IE shall be present if at least one optional feature defined in subclause 6.2.8 is supported

6.2.6.2.7 Type: PatchDocument

Table 6.2.6.2.7-1: Definition of type PatchDocument

Attribute name	Data type	P	Cardinality	Description
N/A	array(PatchItem)	M	1..N	An array of patch instructions to update the NSSAI availability information at the NSSF. See 3GPP TS 29.571 [7].

6.2.6.2.8 Type: NssfEventSubscriptionCreateData

Table 6.2.6.2.8-1: Definition of type NssfEventSubscriptionCreateData

Attribute name	Data type	P	Cardinality	Description
nfNssaiAvailabilityUri	Uri	M	1	Identifies the recipient of notifications sent by the NF service consumer (e.g. AMF) for this subscription
tai	array(Tai)	M	1..N	Identifies the TAI supported by the NF service consumer (e.g. AMF).
event	NssfEventType	M	1	Describes the event to be subscribed for this subscription.

6.2.6.2.9 Type: NssfEventSubscriptionCreatedData

Table 6.2.6.2.9-1: Definition of type NssfEventSubscriptionCreatedData

Attribute name	Data type	P	Cardinality	Description
subscriptionId	String	M	1	Identifies the subscription Id for the created subscription.
authorizedNssaiAvailabilityData	array(AuthorizedNssaiAvailabilityData)	O	0..N	If the authorized NSSAI availability (i.e. any S-NSSAIs restricted per TA and per PLMN in the serving PLMN of the UE) is available, the NSSF may include this IE.

6.2.6.2.10 Type: NssfEventNotification

Table 6.2.6.2.10-1: Definition of type NssfEventNotification

Attribute name	Data type	P	Cardinality	Description
subscriptionId	string	M	1	Indicates which subscription generated event notification. This parameter is generated by NSSF and returned in "Location" header in HTTP responses. This can be useful if a NF use a common call-back URI for multiple subscriptions.
authorizednssaiAvailabilityData	array(AuthorizedNssaiAvailabilityData)	M	1..N	Contains the authorized NSSAI availability information.

6.2.6.3 Simple data types and enumerations

6.2.6.3.1 Introduction

This subclause defines simple data types and enumerations that can be referenced from data structures defined in the previous subclauses.

6.2.6.3.2 Simple data types

The simple data types defined in table 6.2.6.3.2-1 shall be supported.

Table 6.2.6.3.2-1: Simple data types

Type Name	Type Definition	Description
	<one simple data type, e.g. boolean, integer, null, number, string>	

6.2.6.3.3 Enumeration: NssfEventType

Table 6.2.6.3.3-1: Enumeration NssfEventType

Enumeration value	Description
S-NSSAI_RESTRICTED_REPORT	A NF subscribes to this event to receive the current S-NSSAI restricted per TA and per PLMN in the serving PLMN of the UE.

6.2.6.4 Binary data

There is no binary data used for the Nssf_NSSAIAvailability service in this version of the API.

6.2.7 Error Handling

6.2.7.1 General

HTTP error handling shall be supported as specified in subclause 5.2.4 of 3GPP TS 29.500 [4].

6.2.7.2 Protocol Errors

Protocol Error Handling shall be supported as specified in subclause 5.2.7.2 of 3GPP TS 29.500 [4].

6.2.7.3 Application Errors

The common application errors defined in the Table 5.2.7.2-1 in 3GPP TS 29.500 [4] may also be used for the Nnssf_NSSAIAvailability service. The following application errors listed in Table 6.1.7.3-1 are specific for the Nnssf_NSSAIAvailability service.

Table 6.2.7.3-1: Application errors

Application Error	HTTP status code	Description
SNSSAI_NOT_SUPPORTED	403 Forbidden	The SNSSAI provided in the request is not supported in the PLMN.

6.2.8 Feature negotiation

The feature negotiation mechanism specified in subclause 6.6 of 3GPP TS 29.500 [4] shall be used to negotiate the optional features applicable between the NSSF and the NF Service Consumer, for the Nnssf_NSSAIAvailability service, if any.

The NF Service Consumer shall indicate the optional features it supports for the Nnssf_NSSAIAvailability service, if any, by including the supportedFeatures attribute in the HTTP PUT request when requesting the NSSF to update the NSSAI Availability information.

The NSSF shall determine the supported features for the updated NSSAI Availability information resource as specified in subclause 6.6 of 3GPP TS 29.500 [4] and shall indicate the supported features by including the supportedFeatures attribute in the authorized NSSAI availability information it returns in the HTTP response.

The syntax of the supportedFeatures attribute is defined in subclause 5.2.2 of 3GPP TS 29.571 [5].

The following features are defined for the Nnssf_NSSAIAvailability service.

Table 6.2.8-1: Features of supportedFeatures attribute used by Nnssf_NSSAIAvailability service

Feature Number	Feature	M/O	Description
Feature number: The order number of the feature within the supportedFeatures attribute (starting with 1). Feature: A short name that can be used to refer to the bit and to the feature. M/O: Defines if the implementation of the feature is mandatory ("M") or optional ("O"). Description: A clear textual description of the feature.			

6.2.9 Security

As indicated in 3GPP TS 33.501 [11], the access to the Nnssf_NSSAIAvailability API shall be authorized by means of the OAuth2 protocol (see IETF RFC 6749 [12]), using the "Client Credentials" authorization grant, where the NRF (see 3GPP TS 29.510 [13]) plays the role of the authorization server.

An NF Service Consumer, prior to consuming services offered by the Nnssf_NSSAIAvailability API, shall obtain a "token" from the authorization server, by invoking the Access Token Request service, as described in 3GPP TS 29.510 [13], subclause 5.4.2.2.

NOTE: When multiple NRFs are deployed in a network, the NRF used as authorization server is the same NRF that the NF Service Consumer used for discovering the Nnssf_NSSAIAvailability service.

The Nnssf_NSSAIAvailability API does not define any scopes for OAuth2 authorization.

Annex A (normative): OpenAPI specification

A.1 General

This Annex specifies the formal definition of the Nnssf_NSSelection service. It consists of OpenAPI 3.0.0 specifications, in YAML format.

A.2 Nnssf_NSSelection API

```

openapi: 3.0.0

info:
  version: '1.R15.0.0'
  title: 'NSSF NS Selection'
  description: 'NSSF Network Slice Selection Service'
security:
  - oAuth2Clientcredentials: []
servers:
  - url: https://{apiRoot}/nnssf-nssselection/v1
    variables:
      apiRoot:
        default: localhost:8080
paths:
  /network-slice-information:
    get:
      summary: Retrieve the Network Slice Selection Information
      tags:
        - Network Slice Information (Document)
      operationId: Get
      parameters:
        - name: nf-type
          in: query
          description: NF type of the NF service consumer
          required: true
          schema:
            $ref: 'TS29510_Nnrf_NFManagement.yaml#/components/schemas/NFType'
        - name: nf-id
          in: query
          description: NF Instance ID of the NF service consumer
          required: true
          schema:
            $ref: 'TS29571_CommonData.yaml#/components/schemas/NfInstanceId'
        - name: slice-info-request-for-registration
          in: query
          description: Requested network slice information during Registration procedure
          content:
            application/json:
              schema:
                $ref: '#/components/schemas/SliceInfoForRegistration'
        - name: slice-info-request-for-pdu-session
          in: query
          description: Requested network slice information during PDU session establishment
      procedure
        content:
          application/json:
            schema:
              $ref: '#/components/schemas/SliceInfoForPDUSession'
        - name: home-plmn-id
          in: query
          description: PLMN ID of the HPLMN
          content:
            application/json:
              schema:
                $ref: 'TS29571_CommonData.yaml#/components/schemas/PlmnId'
        - name: tai
          in: query
          description: TAI of the UE
          content:

```

```

    application/json:
      schema:
        $ref: 'TS29571_CommonData.yaml#/components/schemas/Tai'
  - name: supported-features
    in: query
    description: Features required to be supported by the NFs in the target slice instance
    content:
      application/json:
        schema:
          $ref: 'TS29571_CommonData.yaml#/components/schemas/SupportedFeatures'

responses:
  '200':
    description: OK (Successful Network Slice Selection)
    content:
      application/json:
        schema:
          $ref: '#/components/schemas/AuthorizedNetworkSliceInfo'
  '403':
    description: Forbidden
    content:
      application/json:
        schema:
          $ref: 'TS29571_CommonData.yaml#/components/schemas/ProblemDetails'
  default:
    description: Unexpected error
    content:
      application/problem+json:
        schema:
          $ref: 'TS29571_CommonData.yaml#/components/schemas/ProblemDetails'

components:
  securitySchemes:
    oAuth2ClientCredentials:
      type: oauth2
      flows:
        clientCredentials:
          tokenUrl: '{nrfApiRoot}/oauth2/token'
          scopes: {}
  schemas:
    AuthorizedNetworkSliceInfo:
      type: object
      required:
        - allowedNssai
      properties:
        allowedNssai:
          $ref: '#/components/schemas/AllowedNssai'
        configuredNssai:
          $ref: '#/components/schemas/ConfiguredNssai'
        targetAmfSet:
          type: string
        candidateAmf:
          type: array
          items:
            $ref: 'TS29571_CommonData.yaml#/components/schemas/NfInstanceId'
        rejectedNssaiInPlmn:
          type: array
          items:
            $ref: 'TS29571_CommonData.yaml#/components/schemas/Snssai'
        rejectedNssaiInTa:
          type: array
          items:
            $ref: 'TS29571_CommonData.yaml#/components/schemas/Snssai'
        nsiInformation:
          $ref: '#/components/schemas/NsiInformation'
        supportedFeatures:
          $ref: 'TS29571_CommonData.yaml#/components/schemas/SupportedFeatures'

    SubscribedSNssai:
      type: object
      required:
        - subscribedSNssai
      properties:
        subscribedSNssai:
          $ref: 'TS29571_CommonData.yaml#/components/schemas/Snssai'
        defaultIndication:
          type: boolean

```

```

SubscribedNssai:
  type: object
  required:
    - subscribedSNssai
  properties:
    subscribedSNssai:
      type: array
      items:
        $ref: '#/components/schemas/SubscribedSNssai'

AllowedSNssai:
  type: object
  required:
    - allowedSNssai
  properties:
    allowedSNssai:
      $ref: 'TS29571_CommonData.yaml#/components/schemas/Snssai'
    nsiInformation:
      type: array
      items:
        $ref: '#/components/schemas/NsiInformation'
    mappedHomeSNssai:
      $ref: 'TS29571_CommonData.yaml#/components/schemas/Snssai'

AllowedNssai:
  type: object
  required:
    - allowedSNssai
  properties:
    allowedSNssai:
      type: array
      items:
        $ref: '#/components/schemas/AllowedSNssai'

NsiInformation:
  type: object
  required:
    - nrfId
  properties:
    nrfId:
      $ref: 'TS29571_CommonData.yaml#/components/schemas/Fqdn'
    nsiId:
      $ref: '#/components/schemas/NsiId'

MappingOfRequestedSNssai:
  type: object
  required:
    - servingSNssai
    - homeSNssai
  properties:
    servingSNssai:
      $ref: 'TS29571_CommonData.yaml#/components/schemas/Snssai'
    homeSNssai:
      $ref: 'TS29571_CommonData.yaml#/components/schemas/Snssai'

MappingOfRequestedNssai:
  type: object
  required:
    - mappingOfRequestedSNssai
  properties:
    mappingOfRequestedSNssai:
      type: array
      items:
        $ref: '#/components/schemas/MappingOfRequestedSNssai'

SliceInfoForRegistration:
  type: object
  required:
    - subscribedNSSAI
  properties:
    subscribedNSSAI:
      $ref: '#/components/schemas/SubscribedNssai'
    requestedNssai:
      type: array
      items:
        $ref: 'TS29571_CommonData.yaml#/components/schemas/Snssai'
    mappingOfRequestedSNssai:
      $ref: '#/components/schemas/MappingOfRequestedNssai'

```

```

SliceInfoForPDUSession:
  type: object
  required:
    - sNssai
    - roamingIndication
  properties:
    sNssai:
      $ref: 'TS29571_CommonData.yaml#/components/schemas/Snssai'
    roamingIndication:
      $ref: '#/components/schemas/RoamingIndication'
    homeSNssai:
      $ref: 'TS29571_CommonData.yaml#/components/schemas/Snssai'

ConfiguredSnssai:
  type: object
  required:
    - configuredSnssai
  properties:
    configuredSnssai:
      $ref: 'TS29571_CommonData.yaml#/components/schemas/Snssai'
    mappedHomeSnssai:
      $ref: 'TS29571_CommonData.yaml#/components/schemas/Snssai'

ConfiguredNssai:
  type: object
  required:
    - configuredSnssai
  properties:
    configuredSnssai:
      type: array
      items:
        $ref: '#/components/schemas/ConfiguredSnssai'

RoamingIndication:
  anyOf:
    - type: string
      enum:
        - NON_ROAMING
        - LOCAL_BREAKOUT
        - HOME_ROUTED_ROAMING
    - type: string
  NsiId:
    type: string

externalDocs:
  description: Documentation
  url: 'http://www.3gpp.org/ftp/Specs/archive/29_series/29.531/'

```

A.3 Nssf_NSSAIAvailability API

openapi: 3.0.0

```

info:
  version: '1.R15.0.0'
  title: 'NSSF NSSAI Availability'
  description: 'NSSF NSSAI Availability Service'
security:
  - oAuth2Clientcredentials: []
servers:
  - url: https://{apiRoot}/nssf-nssaiavailability/v1
    variables:
      apiRoot:
        default: localhost:8080
paths:
  /nssai-availability/{nfId}:
    put:
      summary: Updates/replaces the NSSF with the S-NSSAIs the NF service consumer (e.g AMF)supports
per TA
      tags:
        - Nssf_NSSAIAvailability_Update service operation
      operationId: Update
      parameters:
        - name: nfId
          in: path
          description: Identifier of the NF service consumer instance

```

```

    required: true
    schema:
      $ref: 'TS29571_CommonData.yaml#/components/schemas/NfInstanceId'
  requestBody:
    description: Parameters to update/replace at the NSSF, the S-NSSAIs supported per TA
    required: true
    content:
      application/json:
        schema:
          $ref: '#/components/schemas/NssaiAvailabilityInfo'
  responses:
    '200':
      description: OK (Successful update of SNSSAI information per TA)
      content:
        application/json:
          schema:
            $ref: '#/components/schemas/AuthorizedNssaiAvailabilityInfo'
    '403':
      description: Forbidden
      content:
        application/json:
          schema:
            $ref: 'TS29571_CommonData.yaml#/components/schemas/ProblemDetails'
    '404':
      description: Not Found
      content:
        application/json:
          schema:
            $ref: 'TS29571_CommonData.yaml#/components/schemas/ProblemDetails'
    default:
      description: Unexpected error
      content:
        application/problem+json:
          schema:
            $ref: 'TS29571_CommonData.yaml#/components/schemas/ProblemDetails'

  patch:
    summary: Updates an already existing S-NSSAIs per TA provided by the NF service consumer (e.g
AMF)
    tags:
      - Nnssf_NSSAIAvailability_Update service operation
    operationId: Update
    parameters:
      - name: nfId
        in: path
        description: Identifier of the NF service consumer instance
        required: true
        schema:
          type: string
    requestBody:
      description: JSON Patch instructions to update at the NSSF, the S-NSSAIs supported per TA
      required: true
      content:
        application/json-patch+json:
          schema:
            $ref: '#/components/schemas/PatchDocument'
  responses:
    '200':
      description: OK (Successful update of SNSSAI information per TA)
      content:
        application/json:
          schema:
            $ref: '#/components/schemas/AuthorizedNssaiAvailabilityInfo'
    '403':
      description: Forbidden
      content:
        application/json:
          schema:
            $ref: 'TS29571_CommonData.yaml#/components/schemas/ProblemDetails'
    '404':
      description: Not Found
      content:
        application/json:
          schema:
            $ref: 'TS29571_CommonData.yaml#/components/schemas/ProblemDetails'
    default:

```

```

        description: Unexpected error
        content:
          application/problem+json:
            schema:
              $ref: 'TS29571_CommonData.yaml#/components/schemas/ProblemDetails'

delete:
  summary: Deletes an already existing S-NSSAIs per TA provided by the NF service consumer (e.g
AMF)
  tags:
    - Nnssf_NSSAIAvailability_Update service operation
  operationId: Update
  parameters:
    - name: nfId
      in: path
      description: Identifier of the NF service consumer instance
      required: true
      schema:
        type: string

  responses:
    '204':
      description: No Content (Successful deletion of SNSSAI information per TA)
    '404':
      description: Not Found
      content:
        application/json:
          schema:
            $ref: 'TS29571_CommonData.yaml#/components/schemas/ProblemDetails'

  default:
    description: Unexpected error
    content:
      application/problem+json:
        schema:
          $ref: 'TS29571_CommonData.yaml#/components/schemas/ProblemDetails'

/nssai-availability/subscriptions:
  post:
    summary: Creates subscriptions for notification about updates to NSSAI availability
information
    tags:
      - Nnssf_NSSAIAvailability_Update service operation
    operationId: Subscribe
    requestBody:
      description: Subscription for notification about updates to NSSAI availability information
      required: true
      content:
        application/json:
          schema:
            $ref: '#/components/schemas/NssfEventSubscriptionCreateData'
    callbacks:
      nssaiAvailabilityNotification:
        '{request.body#/nfNssaiAvailabilityUri}':
          post:
            requestBody: # contents of the callback message
              required: true
            content:
              application/json:
                schema:
                  $ref: '#/components/schemas/NssfEventNotification'
            responses:
              '204':
                description: No Content (successful notification)

  responses:
    '201':
      description: Created (Successful creation of subscription for notification)
      content:
        application/json:
          schema:
            $ref: '#/components/schemas/NssfEventSubscriptionCreatedData'
    '403':
      description: Forbidden
      content:
        application/json:
          schema:
            $ref: 'TS29571_CommonData.yaml#/components/schemas/ProblemDetails'

```



```

'404':
  description: Not Found
  content:
    application/json:
      schema:
        $ref: 'TS29571_CommonData.yaml#/components/schemas/ProblemDetails'
  default:
    description: Unexpected error
    content:
      application/problem+json:
        schema:
          $ref: 'TS29571_CommonData.yaml#/components/schemas/ProblemDetails'

delete:
  summary: Deletes an already existing NSSAI availability notification subscription
  tags:
    - Nnssf_NSSAIAvailability_Unsubscribe service operation
  operationId: Unsubscribe
  parameters:
    - name: subscriptionId
      in: path
      description: Identifier of the subscription for notification
      required: true
      schema:
        type: string

  responses:
    '204':
      description: No Content (Successful deletion of subscription for NSSAI Availability
notification)
    '404':
      description: Not Found
      content:
        application/json:
          schema:
            $ref: 'TS29571_CommonData.yaml#/components/schemas/ProblemDetails'

    default:
      description: Unexpected error
      content:
        application/problem+json:
          schema:
            $ref: 'TS29571_CommonData.yaml#/components/schemas/ProblemDetails'

components:
  securitySchemes:
    oAuth2ClientCredentials:
      type: oauth2
      flows:
        clientCredentials:
          tokenUrl: '{nrfApiRoot}/oauth2/token'
          scopes: {}
  schemas:
    NssaiAvailabilityInfo:
      type: object
      required:
        - supportedNssaiAvailabilityData
      properties:
        supportedNssaiAvailabilityData:
          $ref: '#/components/schemas/SupportedNssaiAvailabilityData'
        nfNssaiAvailabilityUri:
          $ref: 'TS29571_CommonData.yaml#/components/schemas/Uri'
        supportedFeatures:
          $ref: 'TS29571_CommonData.yaml#/components/schemas/SupportedFeatures'

    SupportedNssaiAvailabilityData:
      type: object
      required:
        - tai
        - supportedSNssai
      properties:
        tai:
          $ref: 'TS29571_CommonData.yaml#/components/schemas/Tai'
        supportedSNssai:
          type: array
          items:
            $ref: 'TS29571_CommonData.yaml#/components/schemas/Snssai'

```

```
AuthorizedNssaiAvailabilityData:
  type: object
  required:
    - tai
    - supportedSNssai
  properties:
    tai:
      $ref: 'TS29571_CommonData.yaml#/components/schemas/Tai'
    supportedSNssai:
      type: array
      items:
        $ref: 'TS29571_CommonData.yaml#/components/schemas/Snssai'
    restrictedSnssai:
      $ref: '#/components/schemas/RestrictedSnssai'

RestrictedSnssai:
  type: object
  required:
    - homePlmnId
    - sNssai
  properties:
    homePlmnId:
      $ref: 'TS29571_CommonData.yaml#/components/schemas/PlmnId'
    sNssai:
      type: array
      items:
        $ref: 'TS29571_CommonData.yaml#/components/schemas/Snssai'

AuthorizedNssaiAvailabilityInfo:
  type: object
  required:
    - authorizedNssaiAvailabilityData
  properties:
    authorizedNssaiAvailabilityData:
      type: array
      items:
        $ref: '#/components/schemas/AuthorizedNssaiAvailabilityData'
    nfNssaiAvailabilityUri:
      $ref: 'TS29571_CommonData.yaml#/components/schemas/Uri'
    supportedFeatures:
      $ref: 'TS29571_CommonData.yaml#/components/schemas/SupportedFeatures'

NssfEventSubscriptionCreateData:
  type: object
  required:
    - nfNssaiAvailabilityUri
    - tai
    - event
  properties:
    nfNssaiAvailabilityUri:
      $ref: 'TS29571_CommonData.yaml#/components/schemas/Uri'
    tai:
      type: array
      items:
        $ref: 'TS29571_CommonData.yaml#/components/schemas/Tai'
    event:
      $ref: '#/components/schemas/NssfEventType'

NssfEventSubscriptionCreatedData:
  type: object
  required:
    - subscriptionId
  properties:
    subscriptionId:
      type: string
    authorizedNssaiAvailabilityData:
      type: array
      items:
        $ref: '#/components/schemas/AuthorizedNssaiAvailabilityData'

NssfEventNotification:
  type: object
  required:
    - subscriptionId
    - authorizednssaiAvailabilityData
  properties:
    subscriptionId:
      type: string
```

```
    authorizedNssaiAvailabilityData:
      type: array
      items:
        $ref: '#/components/schemas/AuthorizedNssaiAvailabilityData'
  NssfEventType:
    anyOf:
      - type: string
        enum:
          - S-NSSAI_RESTRICTED_REPORT
      - type: string
  PatchDocument:
    type: array
    items:
      $ref: 'TS29571_CommonData.yaml#/components/schemas/PatchItem'

externalDocs:
  description: Documentation
  url: 'http://www.3gpp.org/ftp/Specs/archive/29_series/29.531/'
```

Annex B (informative): Change history

Change history							
Date	Meeting	TDoc	CR	Rev	Cat	Subject/Comment	New version
2017-10	CT4#80	C4-175279				Initial Draft.	0.1.0
2017-10	CT4#81	C4-175398				Implementation of C4-175280	0.2.0
2018-01	CT4#82	C4-181394				Implementation of C4-181240, C4-181242, C4-181244, C4-181355, C4-181356, C4-181357	0.3.0
2018-03	CT4#83	C4-182438				Implementation of C4-182087, C4-182294, C4-182295, C4-182296, C4-182297, C4-182298, C4-182299	0.4.0
2018-03	CT#79	CP-180035				Presented for information	1.0.0
2018-04	CT4#84	C4-183519				Implementation of C4-183068, C4-183071, C4-183431, C4-183432, C4-183433	1.1.0
2018-05	CT4#85	C4-184631				Implementation of C4-184602, C4-184023, C4-184024, C4-184025, C4-184026, C4-184603, C4-184527, C4-184528, C4-184604, C4-184632	1.2.0
2018-06	CT#80	CP-181108				Presented for approval	2.0.0
2018-06	CT#80					Approved in CT#80.	15.0.0