

TTA Standard

정보통신단체표준(기술규격)
TTAT.3G-29.503(R15-15.0.0)

제정일: 2018년 9월

3GPP-(Technical Speciation
Group Core Network and
Terminals; 5G System; Unified
Data Management Services;
Stage 3)



본 문서에 대한 저작권은 TTA에 있으며, TTA와 사전 협의 없이 이 문서의 전체 또는 일부를 상업적 목적으로 복제 또는 배포해서는 안 됩니다.

Copyright 20xx, Telecommunications Technology Association.
All rights reserved.

3GPP TS 29.503 V15.0.0 (2018-06)

Technical Specification

**3rd Generation Partnership Project;
Technical Specification Group Core Network and Terminals;
5G System; Unified Data Management Services;
Stage 3
(Release 15)**



Keywords

3GPP, 5G System

3GPP

Postal address

3GPP support office address

650 Route des Lucioles - Sophia Antipolis
Valbonne - FRANCE
Tel.: +33 4 92 94 42 00 Fax: +33 4 93 65 47 16

Internet

<http://www.3gpp.org>

Copyright Notification

No part may be reproduced except as authorized by written permission.
The copyright and the foregoing restriction extend to reproduction in all media.

© 2018, 3GPP Organizational Partners (ARIB, ATIS, CCSA, ETSI, TSDSI, TTA, TTC).
All rights reserved.

UMTS™ is a Trade Mark of ETSI registered for the benefit of its members
3GPP™ is a Trade Mark of ETSI registered for the benefit of its Members and of the 3GPP Organizational Partners
LTE™ is a Trade Mark of ETSI registered for the benefit of its Members and of the 3GPP Organizational Partners
GSM® and the GSM logo are registered and owned by the GSM Association

Contents

Foreword	10
1 Scope	11
2 References	11
3 Definitions and abbreviations.....	12
3.1 Definitions	12
3.2 Abbreviations.....	12
4 Overview	12
4.1 Introduction.....	12
5 Services offered by the UDM.....	13
5.1 Introduction.....	13
5.2 Nudm_SubscriberDataManagement Service	13
5.2.1 Service Description	13
5.2.2 Service Operations	13
5.2.2.1 Introduction	13
5.2.2.2 Get	13
5.2.2.2.1 General.....	13
5.2.2.2.2 Subscribed Network Slice Selection Assistance Information Retrieval.....	14
5.2.2.2.3 Access and Mobility Subscription Data Retrieval	14
5.2.2.2.4 SMF Selection Subscription Data Retrieval.....	15
5.2.2.2.5 Session Management Subscription Data Retrieval	15
5.2.2.2.6 SMS Subscription Data Retrieval	16
5.2.2.2.7 SMS Management Subscription Data Retrieval.....	16
5.2.2.2.8 UE Context In SMF Data Retrieval	17
5.2.2.2.9 Retrieval Of Multiple Data Sets.....	17
5.2.2.2.10 Identifier Translation	17
5.2.2.3 Subscribe	18
5.2.2.3.1 General.....	18
5.2.2.3.2 Subscription to notifications of data change	18
5.2.2.4 Unsubscribe	19
5.2.2.4.1 General.....	19
5.2.2.4.2 Unsubscribe to notifications of data change	19
5.2.2.5 Notification.....	19
5.2.2.5.1 General.....	19
5.2.2.5.2 Data Change Notification To NF	19
5.3 Nudm_UEContextManagement Service.....	20
5.3.1 Service Description	20
5.3.2 Service Operations	20
5.3.2.1 Introduction	20
5.3.2.2 Registration	21
5.3.2.2.1 General.....	21
5.3.2.2.2 AMF registration for 3GPP access.....	21
5.3.2.2.3 AMF registration for non 3GPP access.....	22
5.3.2.2.4 SMF registration	22
5.3.2.2.5 SMSF Registration for 3GPP Access.....	23
5.3.2.2.6 SMSF Registration for Non 3GPP Access.....	23
5.3.2.3 DeregistrationNotification	24
5.3.2.3.1 General.....	24
5.3.2.3.2 UDM initiated NF Deregistration	24
5.3.2.4 Deregistration	24
5.3.2.4.1 General.....	24
5.3.2.4.2 AMF deregistration for 3GPP access.....	24
5.3.2.4.3 AMF deregistration for non-3GPP access.....	25
5.3.2.4.4 SMF deregistration.....	25
5.3.2.4.5 SMSF Deregistration for 3GPP Access	26

5.3.2.4.6	SMSF Deregistration for Non 3GPP Access.....	26
5.3.2.5	Get	26
5.3.2.5.1	General	26
5.3.2.5.2	Amf3GppAccessRegistration Information Retrieval	27
5.3.2.5.3	AmfNon3GppAccessRegistration Information Retrieval	27
5.3.2.5.4	SmfRegistrations Information Retrieval	27
5.3.2.5.5	SmsfRegistration Information Retrieval for 3GPP Access	28
5.3.2.5.6	SmsfRegistration Information Retrieval for Non-3GPP Access	28
5.3.2.6	Update	28
5.3.2.6.1	General.....	28
5.3.2.6.2	Update A Parameter (e.g. PEI) in the AMF Registration For 3GPP Access.....	29
5.3.2.6.3	Update A Parameter (e.g. PEI) in the AMF Registration For Non 3GPP Access.....	29
5.3.2.7	P-CSCF-RestorationNotification.....	30
5.3.2.7.1	General.....	30
5.3.2.7.2	UDM initiated P-CSCF-Restoration	30
5.4	Nudm_UEAuthentication Service	30
5.4.1	Service Description	30
5.4.2	Service Operations	30
5.4.2.1	Introduction	30
5.4.2.2	Get	31
5.4.2.2.1	General.....	31
5.4.2.2.2	Authentication Information Retrieval	31
5.4.2.3	ResultConfirmationInform	31
5.4.2.3.1	General.....	31
5.4.2.3.2	Authentication Confirmation	31
5.5	Nudm_EventExposure Service	32
5.5.1	Service Description	32
5.5.2	Service Operations	32
5.5.2.1	Introduction	32
5.5.2.2	Subscribe	32
5.5.2.2.1	General.....	32
5.5.2.2.2	Subscription to Notification of event occurrence.....	32
5.5.2.3	Unsubscribe	33
5.5.2.3.1	General.....	33
5.5.2.3.2	Unsubscribe to notifications of event occurrence	33
5.5.2.4	Notify.....	34
5.5.2.4.1	General.....	34
5.5.2.4.2	Event Occurrence Notification.....	34
5.6	Nudm_ParameterProvision Service	34
5.6.1	Service Description	34
5.6.2	Service Operations	34
5.6.2.1	Introduction	34
5.6.2.2	Update	35
5.6.2.2.1	General.....	35
5.6.2.2.2	Subscription data update	35
6	API Definitions	35
6.1	Nudm_SubscriberDataManagement Service API.....	35
6.1.1	API URI	35
6.1.2	Usage of HTTP	35
6.1.2.1	General	35
6.1.2.2	HTTP standard headers	36
6.1.2.2.1	General.....	36
6.1.2.2.2	Content type.....	36
6.1.2.3	HTTP custom headers	36
6.1.2.3.1	General.....	36
6.1.3	Resources	36
6.1.3.1	Overview	36
6.1.3.2	Resource: Nssai	38
6.1.3.2.1	Description.....	38
6.1.3.2.2	Resource Definition	38
6.1.3.2.3	Resource Standard Methods.....	38

6.1.3.2.3.1	GET	38
6.1.3.3	Resource: SdmSubscriptions	39
6.1.3.3.1	Description	39
6.1.3.3.2	Resource Definition	39
6.1.3.3.3	Resource Standard Methods	39
6.1.3.3.3.1	POST	39
6.1.3.4	Resource: Individual subscription	40
6.1.3.4.1	Description	40
6.1.3.4.2	Resource Definition	40
6.1.3.4.3	Resource Standard Methods	40
6.1.3.4.3.1	DELETE	40
6.1.3.5	Resource: AccessAndMobilitySubscriptionData	41
6.1.3.5.1	Description	41
6.1.3.5.2	Resource Definition	41
6.1.3.5.3	Resource Standard Methods	41
6.1.3.5.3.1	GET	41
6.1.3.6	Resource: SmfSelectionSubscriptionData	42
6.1.3.6.1	Description	42
6.1.3.6.2	Resource Definition	42
6.1.3.6.3	Resource Standard Methods	42
6.1.3.6.3.1	GET	42
6.1.3.7	Resource: UeContextInSmfData	43
6.1.3.7.1	Description	43
6.1.3.7.2	Resource Definition	43
6.1.3.7.3	Resource Standard Methods	43
6.1.3.7.3.1	GET	43
6.1.3.8	Resource: SessionManagementSubscriptionData	44
6.1.3.8.1	Description	44
6.1.3.8.2	Resource Definition	44
6.1.3.8.3	Resource Standard Methods	44
6.1.3.8.3.1	GET	44
6.1.3.9	Resource: SMSSubscriptionData	45
6.1.3.9.1	Description	45
6.1.3.9.2	Resource Definition	45
6.1.3.9.3	Resource Standard Methods	45
6.1.3.9.3.1	GET	45
6.1.3.10	Resource: SMSManagementSubscriptionData	46
6.1.3.10.1	Description	46
6.1.3.10.2	Resource Definition	46
6.1.3.10.3	Resource Standard Methods	46
6.1.3.10.3.1	GET	46
6.1.3.11	Resource: Supi	47
6.1.3.11.1	Description	47
6.1.3.11.2	Resource Definition	47
6.1.3.11.3	Resource Standard Methods	47
6.1.3.11.3.1	GET	47
6.1.3.12	Resource: IdTranslationResult	48
6.1.3.12.1	Description	48
6.1.3.12.2	Resource Definition	48
6.1.3.12.3	Resource Standard Methods	48
6.1.3.12.3.1	GET	48
6.1.4	Custom Operations without associated resources	48
6.1.5	Notifications	49
6.1.5.1	General	49
6.1.5.2	Data Change Notification	49
6.1.6	Data Model	49
6.1.6.1	General	49
6.1.6.2	Structured data types	51
6.1.6.2.1	Introduction	51
6.1.6.2.2	Type: Nssai	51
6.1.6.2.3	Type: SdmSubscription	51
6.1.6.2.4	Type: AccessAndMobilitySubscriptionData	51

6.1.6.2.5	Type: SmfSelectionSubscriptionData	52
6.1.6.2.6	Type: DnnInfo	52
6.1.6.2.7	Type: SnsaiInfo	52
6.1.6.2.8	Type: SessionManagementSubscriptionData	52
6.1.6.2.9	Type: DnnConfiguration	53
6.1.6.2.10	Type: 5GQosProfile	53
6.1.6.2.11	Type: PduSessionTypes	53
6.1.6.2.12	Type: SscModes	53
6.1.6.2.13	Type: SmsSubscriptionData	54
6.1.6.2.14	Type: SmsManagementSubscriptionData	54
6.1.6.2.15	Type: SubscriptionDataSets	54
6.1.6.2.16	Type: UeContextInSmfData	54
6.1.6.2.17	Type: PduSession	55
6.1.6.2.18	Type: IdTranslationResult	55
6.1.6.2.19	Type: AreaRestriction	55
6.1.6.2.20	Type: AreaInformation	55
6.1.6.2.21	Type: ModificationNotification	55
6.1.6.2.22	Type: IpAddress	56
6.1.6.3	Simple data types and enumerations	56
6.1.6.3.1	Introduction	56
6.1.6.3.2	Simple data types	56
6.1.6.3.3	Enumeration: DataSetName	57
6.1.6.3.4	Enumeration: SmsSupport	57
6.1.6.3.5	Enumeration: RestrictionType	57
6.1.6.3.6	Enumeration: CoreNetworkType	57
6.1.7	Error Handling	57
6.1.8	Feature Negotiation	57
6.1.9	Security	58
6.2	Nudm_UEContextManagement Service API	58
6.2.1	API URI	58
6.2.2	Usage of HTTP	58
6.2.2.1	General	58
6.2.2.2	HTTP standard headers	58
6.2.2.2.1	General	58
6.2.2.2.2	Content type	58
6.2.2.3	HTTP custom headers	59
6.2.2.3.1	General	59
6.2.3	Resources	59
6.2.3.1	Overview	59
6.2.3.2	Resource: Amf3GppAccessRegistration	60
6.2.3.2.1	Description	60
6.2.3.2.2	Resource Definition	60
6.2.3.2.3	Resource Standard Methods	61
6.2.3.2.3.1	PUT	61
6.2.3.2.3.2	PATCH	61
6.2.3.2.3.3	GET	62
6.2.3.3	Resource: AmfNon3GppAccessRegistration	62
6.2.3.3.1	Description	62
6.2.3.3.2	Resource Definition	62
6.2.3.3.3	Resource Standard Methods	63
6.2.3.3.3.1	PUT	63
6.2.3.3.3.2	PATCH	63
6.2.3.3.3.3	GET	63
6.2.3.4	Resource: SmfRegistrations	64
6.2.3.4.1	Description	64
6.2.3.4.2	Resource Definition	64
6.2.3.4.3	Resource Standard Methods	64
6.2.3.5	Resource: IndividualSmfRegistration	64
6.2.3.5.1	Resource Definition	64
6.2.3.5.2	Resource Standard Methods	65
6.2.3.5.2.1	PUT	65
6.2.3.5.2.2	DELETE	65

6.2.3.6	Resource: Smsf3GppAccessRegistration	66
6.2.3.6.1	Description.....	66
6.2.3.6.2	Resource Definition	66
6.2.3.6.3	Resource Standard Methods.....	66
6.2.3.6.3.1	PUT	66
6.2.3.6.3.2	DELETE.....	67
6.2.3.6.3.3	GET	67
6.2.3.7	Resource: SmsfNon3GppAccessRegistration.....	67
6.2.3.7.1	Description.....	67
6.2.3.7.2	Resource Definition	68
6.2.3.7.3	Resource Standard Methods.....	68
6.2.3.7.3.1	PUT	68
6.2.3.7.3.2	DELETE.....	68
6.2.3.7.3.3	GET	69
6.2.4	Custom Operations without associated resources	69
6.2.5	Notifications.....	69
6.2.5.1	General	69
6.2.5.2	Deregistration Notification	69
6.2.5.3	P-CSCF Restoration Notification	70
6.2.6	Data Model.....	71
6.2.6.1	General	71
6.2.6.2	Structured data types	71
6.2.6.2.1	Introduction.....	71
6.2.6.2.2	Type: Amf3GppAccessRegistration	72
6.2.6.2.3	Type: AmfNon3GppAccessRegistration	72
6.2.6.2.4	Type: SmfRegistration	73
6.2.6.2.5	Type: DeregistrationData.....	73
6.2.6.2.6	Type: SmsfRegistration	73
6.2.6.2.7	Type: Amf3GppAccessRegistrationModification.....	73
6.2.6.2.8	Type: AmfNon3GppAccessRegistrationModification.....	74
6.2.6.2.9	Type: PscsfRestorationNotification	74
6.2.6.3	Simple data types and enumerations.....	74
6.2.6.3.1	Introduction.....	74
6.2.6.3.2	Simple data types	74
6.2.6.3.3	Enumeration: DeregistrationReason	74
6.2.6.3.4	Enumeration: ImsVoPS	74
6.2.7	Error Handling	75
6.2.8	Feature Negotiation.....	75
6.2.9	Security	75
6.3	Nudm_UEAuthentication Service API.....	75
6.3.1	API URI	75
6.3.2	Usage of HTTP	76
6.3.2.1	General	76
6.3.2.2	HTTP standard headers	76
6.3.2.2.1	General.....	76
6.3.2.2.2	Content type.....	76
6.3.2.3	HTTP custom headers	76
6.3.2.3.1	General.....	76
6.3.3	Resources	76
6.3.3.1	Overview	76
6.3.3.2	Resource: SecurityInformation.....	77
6.3.3.2.1	Description.....	77
6.3.3.2.2	Resource Definition	77
6.3.3.2.3	Resource Standard Methods.....	77
6.3.3.2.4	Resource Custom Operations.....	77
6.3.3.2.4.1	Overview	77
6.3.3.2.4.2	Operation: generate-auth-data	78
6.3.3.2.4.2.1	Description.....	78
6.3.3.2.4.2.2	Operation Definition.....	78
6.3.3.3	Resource: AuthEvents	78
6.3.3.3.1	Description.....	78
6.3.3.3.2	Resource Definition	78

6.3.3.3.3	Resource Standard Methods.....	78
6.3.3.3.3.1	POST	78
6.3.4	Custom Operations without associated resources	79
6.3.5	Notifications.....	79
6.3.6	Data Model.....	79
6.3.6.1	General	79
6.3.6.2	Structured data types	80
6.3.6.2.1	Introduction.....	80
6.3.6.2.2	Type: AuthenticationInfoRequest.....	80
6.3.6.2.3	Type: AuthenticationInfoResult.....	80
6.3.6.2.4	Type: AvEapAkaPrime.....	80
6.3.6.2.5	Type: Av5GHeAka.....	81
6.3.6.2.6	Type: ResynchronizationInfo.....	81
6.3.6.2.7	Type: AuthEvent.....	81
6.3.6.2.8	Type: AuthenticationVector.....	81
6.3.6.3	Simple data types and enumerations.....	81
6.3.6.3.1	Introduction.....	81
6.3.6.3.2	Simple data types	81
6.3.6.3.3	Enumeration: AuthType.....	82
6.3.6.3.4	Enumeration: AvType.....	82
6.3.7	Error Handling	82
6.3.8	Feature Negotiation.....	82
6.3.9	Security	83
6.4	Nudm_EventExposure Service API.....	83
6.4.1	API URI	83
6.4.2	Usage of HTTP	83
6.4.2.1	General	83
6.4.2.2	HTTP standard headers	83
6.4.2.2.1	General.....	83
6.4.2.2.2	Content type.....	83
6.4.2.3	HTTP custom headers	83
6.4.2.3.1	General.....	83
6.4.3	Resources	84
6.4.3.1	Overview	84
6.4.3.2	Resource: EeSubscriptions	84
6.4.3.2.1	Description.....	84
6.4.3.2.2	Resource Definition	84
6.4.3.2.3	Resource Standard Methods.....	85
6.4.3.2.3.1	POST.....	85
6.4.3.3	Resource: Individual subscription	85
6.4.3.3.1	Resource Definition	85
6.4.3.3.1	Resource Standard Methods.....	85
6.4.3.3.1.1	DELETE.....	85
6.4.4	Custom Operations without associated resources	86
6.4.5	Notifications.....	86
6.4.5.1	General	86
6.4.5.2	Event Occurrence Notification	86
6.4.6	Data Model.....	87
6.4.6.1	General	87
6.4.6.2	Structured data types	87
6.4.6.2.1	Introduction.....	87
6.4.6.2.2	Type: EeSubscription.....	88
6.4.6.2.3	Type: MonitoringConfiguration.....	88
6.4.6.2.4	Type: MonitoringReport	88
6.4.6.2.5	Type: Report	88
6.4.6.2.6	Type: ReportingOptions.....	88
6.4.6.2.7	Type: ChangeOfSupiPeiAssociationReport.....	89
6.4.6.2.8	Type: RoamingStatusReport.....	89
6.4.6.3	Simple data types and enumerations.....	89
6.4.6.3.1	Introduction.....	89
6.4.6.3.2	Simple data types	89
6.4.6.3.3	Enumeration: EventType	89

6.4.7	Error Handling	89
6.4.8	Feature Negotiation	91
6.4.9	Security	91
6.5	Nudm_ParameterProvision Service API.....	91
6.5.1	API URI	91
6.5.2	Usage of HTTP	91
6.5.2.1	General	91
6.5.2.2	HTTP standard headers	91
6.5.2.2.1	General.....	91
6.5.2.2.2	Content type.....	91
6.5.2.3	HTTP custom headers	92
6.5.2.3.1	General.....	92
6.5.3	Resources	92
6.5.3.1	Overview	92
6.5.3.2	Resource: PpData	92
6.5.3.2.1	Description.....	92
6.5.3.2.2	Resource Definition	92
6.5.3.2.3	Resource Standard Methods.....	93
6.5.3.2.3.1	PATCH.....	93
6.5.4	Custom Operations without associated resources	93
6.5.5	Notifications	93
6.5.6	Data Model.....	93
6.5.6.1	General	93
6.5.6.2	Structured data types	94
6.5.6.2.1	Introduction.....	94
6.5.6.2.2	Type: PpData	94
6.5.6.2.3	Type: CommunicationCharacteristics	94
6.5.6.2.4	Type: PpSubsRegTimer	94
6.5.6.2.5	Type: PpActiveTime	95
6.5.6.3	Simple data types and enumerations.....	95
6.5.6.3.1	Introduction.....	95
6.5.6.3.2	Simple data types	95
6.5.6.3.3	Enumeration: <EnumType1>.....	95
6.5.7	Error Handling	95
6.5.8	Security	95
Annex A (normative):	OpenAPI specification.....	96
A.1	General.....	96
A.2	Nudm_SDM API	96
A.3	Nudm_UECM API	107
A.4	Nudm_UEAU API.....	115
A.5	Nudm_EE API.....	118
A.6	Nudm_PP API	122
Annex B (informative):	Stateless UDMs.....	123
Annex C (informative):	Change history	126

Foreword

This Technical Specification has been produced by the 3rd Generation Partnership Project (3GPP).

The contents of the present document are subject to continuing work within the TSG and may change following formal TSG approval. Should the TSG modify the contents of the present document, it will be re-released by the TSG with an identifying change of release date and an increase in version number as follows:

Version x.y.z

where:

- x the first digit:
 - 1 presented to TSG for information;
 - 2 presented to TSG for approval;
 - 3 or greater indicates TSG approved document under change control.
- y the second digit is incremented for all changes of substance, i.e. technical enhancements, corrections, updates, etc.
- z the third digit is incremented when editorial only changes have been incorporated in the document.

1 Scope

The present document specifies the stage 3 protocol and data model for the Nudm Service Based Interface. It provides stage 3 protocol definitions and message flows, and specifies the API for each service offered by the UDM.

The 5G System stage 2 architecture and procedures are specified in 3GPP TS 23.501 [2] and 3GPP TS 23.502 [3].

The Technical Realization of the Service Based Architecture and the Principles and Guidelines for Services Definition are specified in 3GPP TS 29.500 [4] and 3GPP TS 29.501 [5].

2 References

The following documents contain provisions which, through reference in this text, constitute provisions of the present document.

- References are either specific (identified by date of publication, edition number, version number, etc.) or non-specific.
- For a specific reference, subsequent revisions do not apply.
- For a non-specific reference, the latest version applies. In the case of a reference to a 3GPP document (including a GSM document), a non-specific reference implicitly refers to the latest version of that document *in the same Release as the present document*.

- [1] 3GPP TR 21.905: "Vocabulary for 3GPP Specifications".
- [2] 3GPP TS 23.501: "System Architecture for the 5G System; Stage 2".
- [3] 3GPP TS 23.502: "Procedures for the 5G System; Stage 2".
- [4] 3GPP TS 29.500: "5G System; Technical Realization of Service Based Architecture; Stage 3".
- [5] 3GPP TS 29.501: "5G System; Principles and Guidelines for Services Definition; Stage 3".
- [6] 3GPP TS 33.501: "Security Architecture and Procedures for 5G System".
- [7] 3GPP TS 29.571: "5G System; Common Data Types for Service Based Interfaces Stage 3".
- [8] 3GPP TS 23.003: "Numbering, addressing and identification".
- [9] 3GPP TS 29.504: "5G System; Unified Data Repository Services; Stage 3".
- [10] 3GPP TS 29.505: "5G System; Usage of the Unified Data Repository Services for Subscription Data; Stage 3".
- [11] 3GPP TS 32.251: "Charging management; Packet Switched (PS) domain charging".
- [12] 3GPP TS 32.298: "Charging management; Charging Data Record (CDR) parameter description".
- [13] IETF RFC 7540: "Hypertext Transfer Protocol Version 2 (HTTP/2)".
- [14] OpenAPI Initiative, "OpenAPI 3.0.0 Specification", <https://github.com/OAI/OpenAPI-Specification/blob/master/versions/3.0.0.md>
- [15] IETF RFC 8259: "The JavaScript Object Notation (JSON) Data Interchange Format".
- [16] IETF RFC 7807: "Problem Details for HTTP APIs".
- [17] IETF RFC 7396: "JSON Merge Patch".
- [18] IETF RFC 6749: "The OAuth 2.0 Authorization Framework".
- [19] 3GPP TS 29.510: "Network Function Repository Services; Stage 3".

3 Definitions and abbreviations

3.1 Definitions

For the purposes of the present document, the terms and definitions given in 3GPP TR 21.905 [1] and the following apply. A term defined in the present document takes precedence over the definition of the same term, if any, in 3GPP TR 21.905 [1].

3.2 Abbreviations

For the purposes of the present document, the abbreviations given in 3GPP TR 21.905 [1] and the following apply. An abbreviation defined in the present document takes precedence over the definition of the same abbreviation, if any, in 3GPP TR 21.905 [1].

4 Overview

4.1 Introduction

Within the 5GC, the UDM offers services to the AMF, SMF, SMSF, NEF and AUSF via the Nudm service based interface (see 3GPP TS 23.501 [2] and 3GPP TS 23.502 [3]).

Figure 4.1-1 provides the reference model (in service based interface representation and in reference point representation), with focus on the UDM.

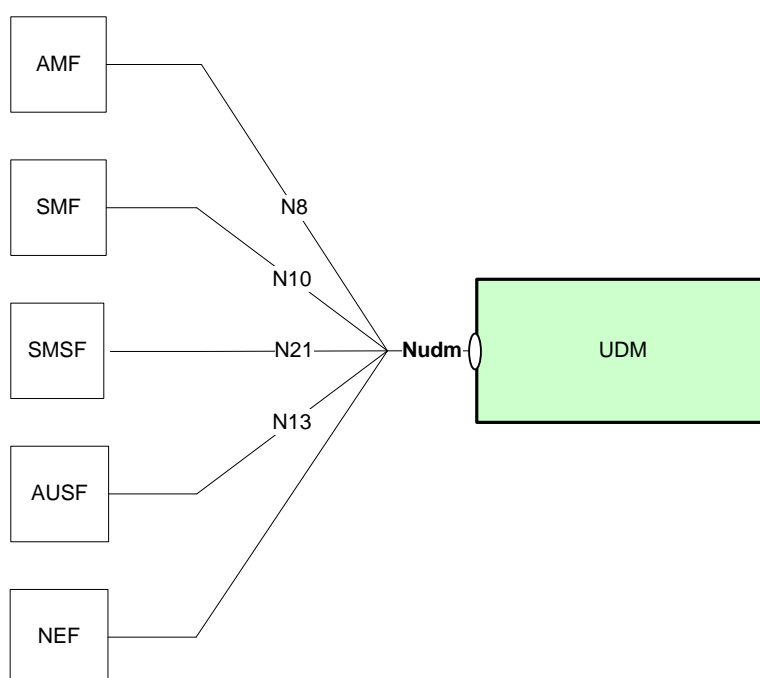

Figure 4.1-1: Reference model – UDM

The functionalities supported by the UDM are listed in subclause 6.2.7 of 3GPP TS 23.501 [2].

5 Services offered by the UDM

5.1 Introduction

The UDM offers the following services via the Nudm interface:

- Nudm_SubscriberDataManagement Service
- Nudm_UEContextManagement Service
- Nudm_UEAuthentication Service
- Nudm_EventExposure Service
- Nudm_ParameterProvision Service

All scenarios shown in the following subclauses assume that the UDM is stateful and stores information in local memory. However, the UDM may be stateless and stores information externally in the UDR. If so, the stateless UDM makes use of Nudr services as specified in 3GPP TS 29.504 [9] and 3GPP TS 29.505 [10] to retrieve required data from the UDR and store them locally before processing an incoming request. Processing the incoming request may then include updating data in the UDR or subscribing to data change notifications at the UDR by consuming the appropriate Nudr services. After processing the incoming request, the UDM may delete the locally stored data. See Annex B.

5.2 Nudm_SubscriberDataManagement Service

5.2.1 Service Description

See 3GPP TS 23.501 [2] table 7.2.5-1.

5.2.2 Service Operations

5.2.2.1 Introduction

For the Nudm_SubscriberDataManagement service the following service operations are defined:

- Get
- Subscribe
- Unsubscribe
- Notification

The Nudm_SubscriberDataManagement Service is used by Consumer NFs (AMF, SMF, SMSF) to retrieve the UE's subscription data relevant to the consumer NF from the UDM by means of the Get service operation.

It is also used by Consumer NFs to subscribe to notifications of data change by means of the Subscribe service operation.

It is also used to unsubscribe from notifications of data changes by means of the Unsubscribe service operation.

It is also used by the Consumer NFs (AMF, SMF, SMSF) that have previously subscribed, to get notified by means of the Notification service operation when UDM decides to modify the subscribed data.

5.2.2.2 Get

5.2.2.2.1 General

The following procedures using the Get service operation are supported:

- Subscribed Network Slice Selection Assistance Information Retrieval
- Access and Mobility Subscription Data Retrieval
- SMF Selection Subscription Data Retrieval
- Session Management Subscription Data Retrieval
- SMS Subscription Data Retrieval
- SMS Management Subscription Data Retrieval
- Retrieval Of Multiple Data Sets
- Identifier Translation

5.2.2.2.2 Subscribed Network Slice Selection Assistance Information Retrieval

Figure 5.2.2.2.2-1 shows a scenario where the NF service consumer (e.g. AMF) sends a request to the UDM to receive the UE's NSSAI (see also 3GPP TS 23.502 [3] figure 4.2.2.2.3-1 step 3). The request contains the UE's identity ($\{/supi\}$), the type of the requested information ($\{/nssai\}$) and query parameters (supportedFeatures, plmn-id).

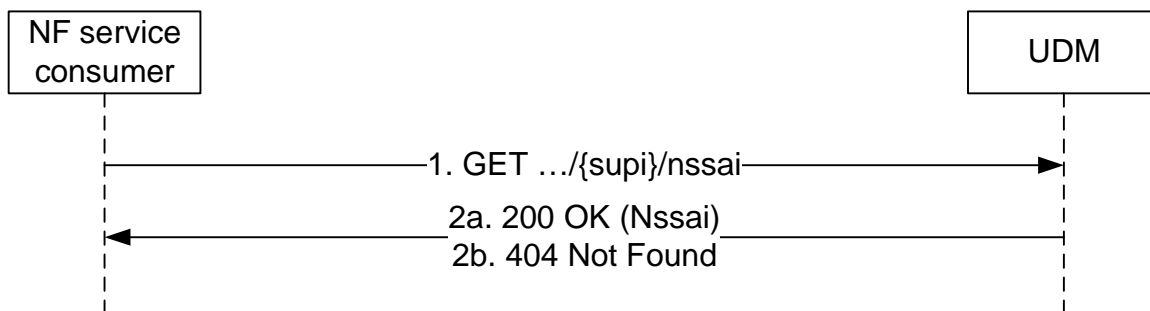

Figure 5.2.2.2.2-1: Requesting a UE's NSSAI

1. The NF service consumer (e.g. AMF) sends a GET request to the resource representing the UE's subscribed NSSAI, with query parameters indicating the supportedFeatures and/or plmn-id.
- 2a. On success, the UDM responds with "200 OK" with the message body containing the UE's NSSAI as relevant for the requesting NF service consumer.
- 2b. If there is no valid subscription data for the UE, HTTP status code "404 Not Found" shall be returned including additional error information in the response body (in the "ProblemDetails" element).

5.2.2.2.3 Access and Mobility Subscription Data Retrieval

Figure 5.2.2.2.3-1 shows a scenario where the NF service consumer (e.g. AMF) sends a request to the UDM to receive the UE's Access and Mobility Subscription data (see also 3GPP TS 23.502 [3] figure 4.2.2.2.2-1 step 14). The request contains the UE's identity ($\{/supi\}$), the type of the requested information ($\{/am-data\}$) and query parameters (supportedFeatures, plmn-id).

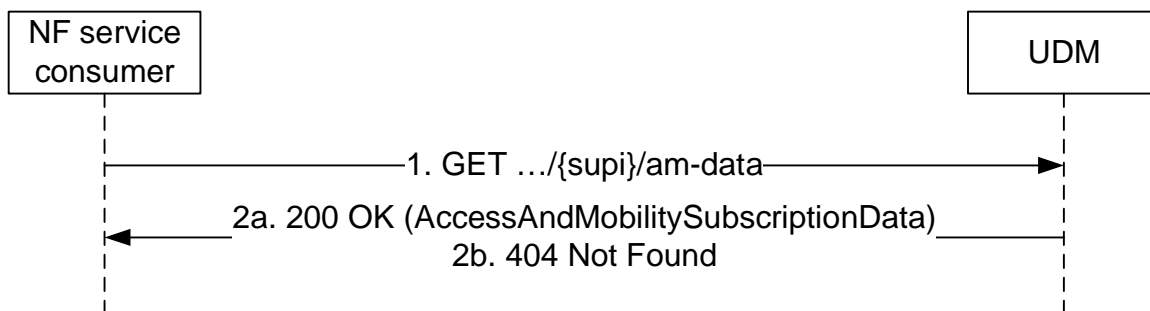

Figure 5.2.2.2.3-1: Requesting a UE's Access and Mobility Subscription Data

1. The NF service consumer (e.g. AMF) sends a GET request to the resource representing the UE's Access and Mobility Subscription Data, with query parameters indicating the supportedFeatures and/or plmn-id.
- 2a. On Success, the UDM responds with "200 OK" with the message body containing the UE's Access and Mobility Subscription Data as relevant for the requesting NF service consumer.
- 2b. If there is no valid subscription data for the UE, HTTP status code "404 Not Found" shall be returned including additional error information in the response body (in the "ProblemDetails" element).

5.2.2.2.4 SMF Selection Subscription Data Retrieval

Figure 5.2.2.2.4-1 shows a scenario where the NF service consumer (e.g. AMF) sends a request to the UDM to receive the UE's SMF Selection Subscription data (see also 3GPP TS 23.502 [3] figure 4.2.2.2.2-1 step 14). The request contains the UE's identity ($\{supi\}$), the type of the requested information ($\{smf-select-data\}$) and query parameters (supportedFeatures, plmn-id).

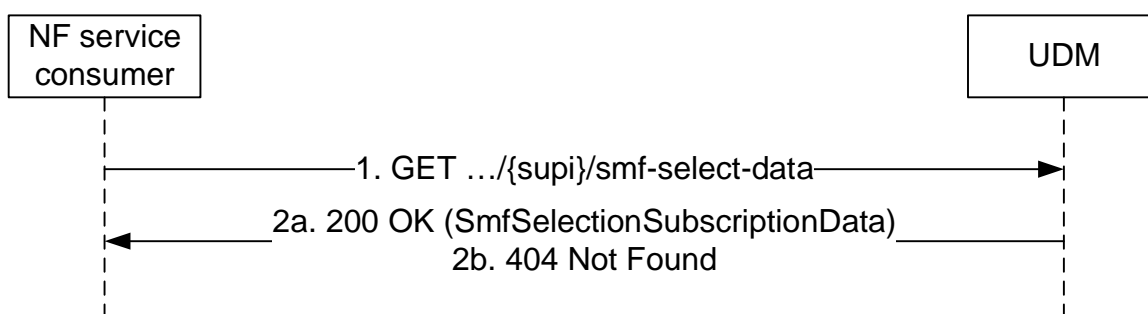

Figure 5.2.2.2.4-1: Requesting a UE's SMF Selection Subscription Data

1. The NF service consumer (e.g. AMF) sends a GET request to the resource representing the UE's SMF Selection Subscription Data, with query parameters indicating the supportedFeatures and/or plmn-id.
- 2a. On success, the UDM responds with "200 OK" with the message body containing the UE's SMF Selection Subscription Data as relevant for the requesting NF service consumer.
- 2b. If there is no valid subscription data for the UE, HTTP status code "404 Not Found" shall be returned including additional error information in the response body (in the "ProblemDetails" element).

5.2.2.2.5 Session Management Subscription Data Retrieval

Figure 5.2.2.2.5-1 shows a scenario where the NF service consumer (e.g. SMF) sends a request to the UDM to receive the UE's session management subscription data (see also 3GPP TS 23.502 [3] figure 4.3.2.2.1-1 step 4a-4b). The request contains the UE's identity ($\{supi\}$), the type of the requested information ($\{sm-data\}$), and query parameters (singleNssai, dnn, supportedFeatures, plmn-id).

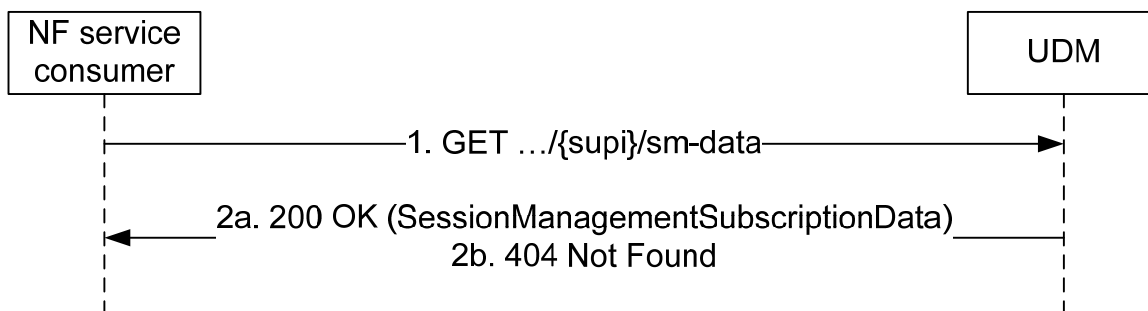

Figure 5.2.2.2.5-1: Requesting a UE's Session Management Subscription Data

1. The NF service consumer (e.g. SMF) sends a GET request to the resource representing the UE's session management subscription data, with query parameters indicating the selected network slice and/or the DNN and/or supportedFeatures and/or plmn-id.
- 2a. On success, the UDM responds with "200 OK", the message body containing the UE's session management subscription data as relevant for the requesting NF service consumer.
- 2b. If there is no valid subscription data for the UE, or if the UE subscription data exists, but the requested session management subscription is not available (e.g. query parameter contains network slice and/or DNN that does not belong to the UE subscription), HTTP status code "404 Not Found" shall be returned including additional error information in the response body (in the "ProblemDetails" element).

5.2.2.2.6 SMS Subscription Data Retrieval

Figure 5.2.2.2.6-1 shows a scenario where the NF service consumer (e.g. AMF) sends a request to the UDM to receive the UE's SMS Subscription Data (see also 3GPP TS 23.502 [3], section 4.13.3.1). The request contains the UE's identity ($\{/supi\}$) and the type of the requested information ($\{/sms-data\}$).

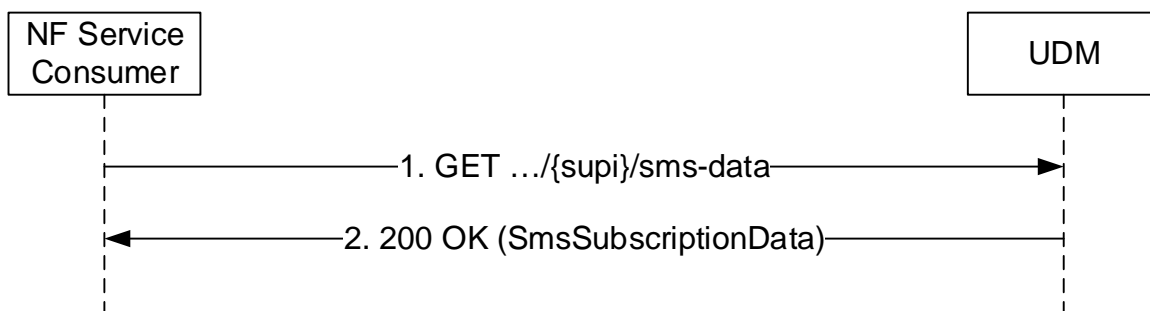

Figure 5.2.2.2.6-1: Requesting UE's SMS Subscription Data

1. The NF Service Consumer (e.g. AMF) sends a GET request to the resource representing the UE's SMS Subscription Data.
2. The UDM responds with "200 OK" with the message body containing the UE's SMS Subscription Data.

5.2.2.2.7 SMS Management Subscription Data Retrieval

Figure 5.2.2.2.7-1 shows a scenario where the NF service consumer (e.g. SMSF) sends a request to the UDM to receive the UE's SMS Management Subscription Data (see also 3GPP TS 23.502 [3], section 4.13.3.1). The request contains the UE's identity ($\{/supi\}$) and the type of the requested information ($\{/sms-mng-data\}$).

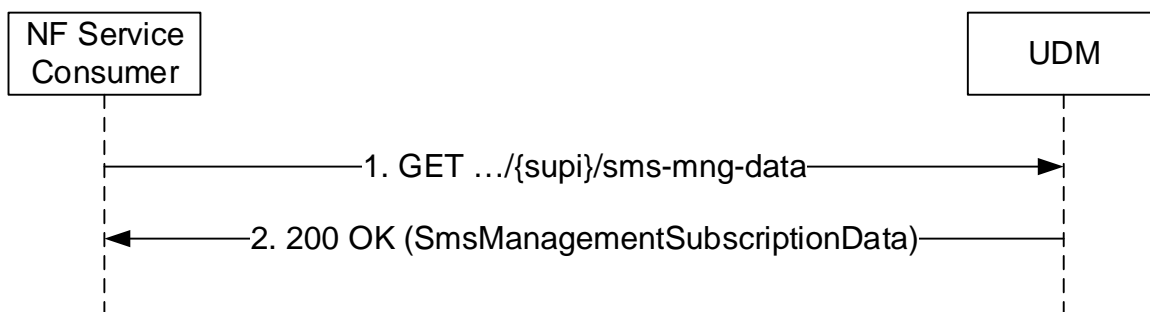

Figure 5.2.2.2.7-1: Requesting UE's SMS Management Subscription Data

1. The NF Service Consumer (e.g. SMSF) sends a GET request to the resource representing the UE's SMS Management Subscription Data.
2. The UDM responds with "200 OK" with the message body containing the UE's SMS Management Subscription Data.

5.2.2.2.8 UE Context In SMF Data Retrieval

Figure 5.2.2.2.8-1 shows a scenario where the NF service consumer (e.g. AMF) sends a request to the UDM to receive the UE's Context In SMF data (see also 3GPP TS 23.502 [3] figure 4.2.2.2.2-1 step 14). The request contains the UE's identity ($\{/supi\}$), the type of the requested information ($\{/ue-context-smf-data\}$) and query parameters ($\{supportedFeatures\}$).

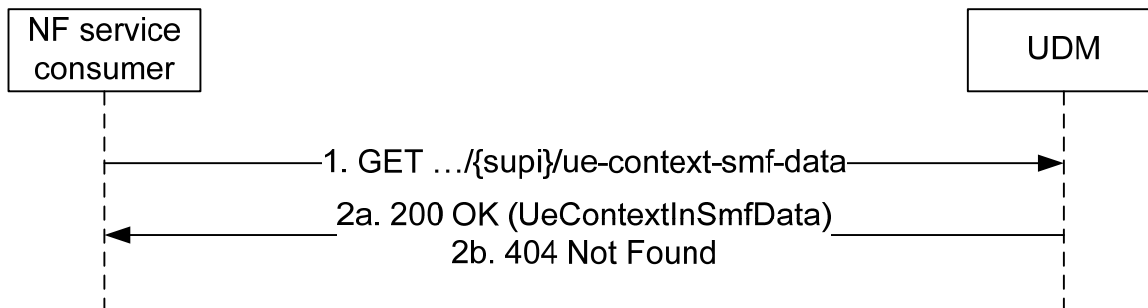

Figure 5.2.2.2.8-1: Requesting a UE's Context in SMF Data

1. The NF service consumer (e.g. AMF) shall send a GET request to the resource representing the UE's Context In SMF Data, with query parameters indicating the supportedFeatures.
- 2a. On Success, the UDM shall respond with "200 OK" with the message body containing the UE's Context In SMF Data as relevant for the requesting NF service consumer.
- 2b. If there is no valid subscription data for the UE, HTTP status code "404 Not Found" shall be returned including additional error information in the response body (in the "ProblemDetails" element).

5.2.2.2.9 Retrieval Of Multiple Data Sets

Figure 5.2.2.2.9-1 shows a scenario where the NF service consumer (e.g. AMF) sends a request to the UDM to receive the UE's Access and Mobility Subscription data and the the UE's SMF Selection Subscription data with a single request. The request contains the UE's identity ($\{/supi\}$) and query parameters identifying the requested data sets ($\{?dataset-names=AM, SMF_SEL\}$).

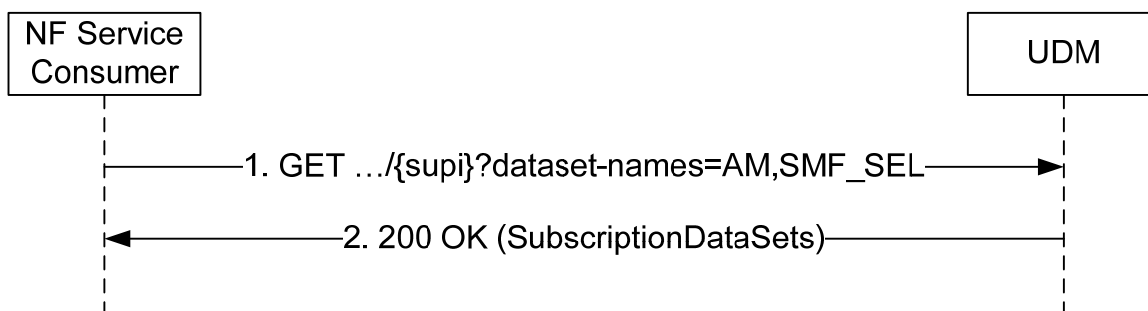

Figure 5.2.2.2.9-1: Retrieval of Multiple Data Sets

1. The NF Service Consumer (e.g. AMF) sends a GET request to the resource representing the $\{supi\}$. Query parameters indicate the requested data sets.
2. The UDM responds with "200 OK" with the message body containing the requested data sets.

5.2.2.2.10 Identifier Translation

Figure 5.2.2.2.10-1 shows a scenario where the NF service consumer (e.g. NEF) sends a request to the UDM to receive the SUPI that corresponds to the provided GPSI (see also 3GPP TS 23.502 [3], section 4.13.2.2). The request contains the UE's identity ($\{/gpsi\}$) and the type of the requested information ($\{/id-translation-result\}$).

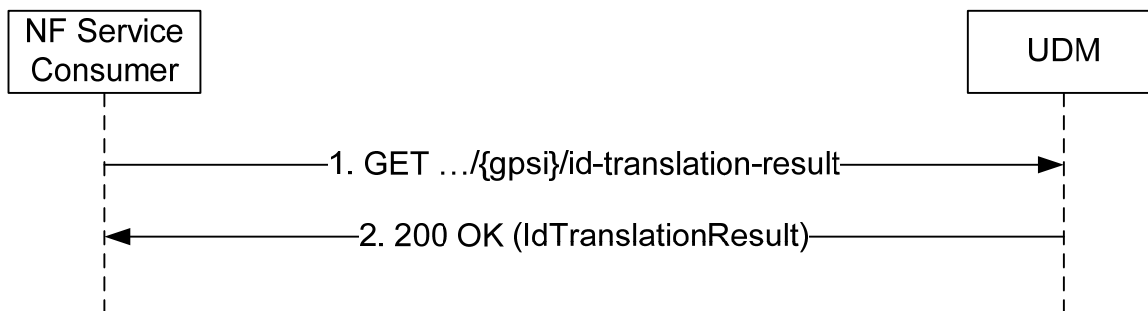

Figure 5.2.2.2.10-1: Identifier Translation

1. The NF Service Consumer (e.g. NEF) shall send a GET request to the resource representing the IdTranslationResult.
2. The UDM shall respond with "200 OK" with the message body containing the UE's SUPI.

5.2.2.3 Subscribe

5.2.2.3.1 General

The following procedures using the Subscribe service operation are supported:

- Subscription to notification of data change

5.2.2.3.2 Subscription to notifications of data change

Figure 5.2.2.3.2-1 shows a scenario where the NF service consumer sends a request to the UDM to subscribe to notifications of data change (see also 3GPP TS 23.502 [3] figure 4.2.2.2.2-1 step 14). The request contains a callback URI and the URI of the monitored resource.

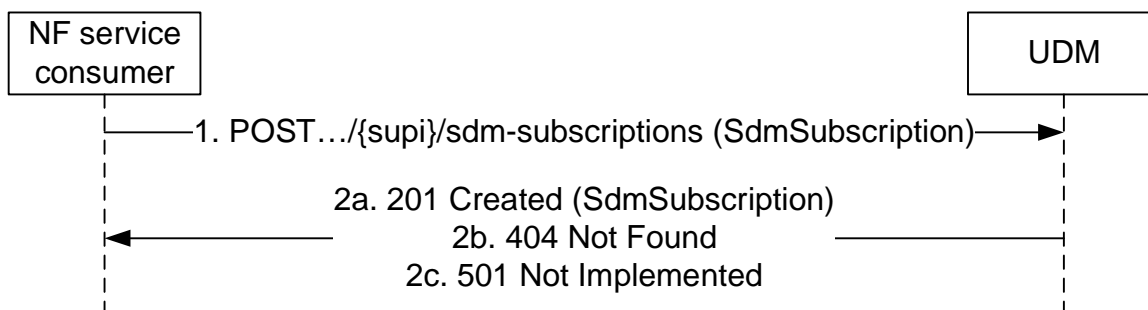

Figure 5.2.2.3.2-1: NF service consumer subscribes to notifications

1. The NF service consumer sends a POST request to the parent resource (collection of subscriptions) (.../{supi}/sdm-subscriptions), to create a subscription as present in message body.
- 2a. On success, the UDM responds with "201 Created" with the message body containing a representation of the created subscription. The Location HTTP header shall contain the URI of the created subscription.
- 2b. If there is no valid subscription data for the UE, HTTP status code "404 Not Found" shall be returned including additional error information in the response body (in the "ProblemDetails" element).
- 2c. If the UE subscription data exist, but the requested subscription to data change notification cannot be created (e.g. due to an invalid/unsupported data reference to be monitored, contained in the SdmSubscription parameter), HTTP status code "501 Not Implemented" shall be returned including additional error information in the response body (in the "ProblemDetails" element).

5.2.2.4 Unsubscribe

5.2.2.4.1 General

The following procedures using the Unsubscribe service operation are supported:

- Unsubscribe to notification of data change

5.2.2.4.2 Unsubscribe to notifications of data change

Figure 5.2.2.4.2-1 shows a scenario where the NF service consumer sends a request to the UDM to unsubscribe from notifications of data changes (see also 3GPP TS 23.502 [3] figure 4.2.2.2.2-1 step 14). The request contains the URI previously received in the Location HTTP header of the response to the subscription.

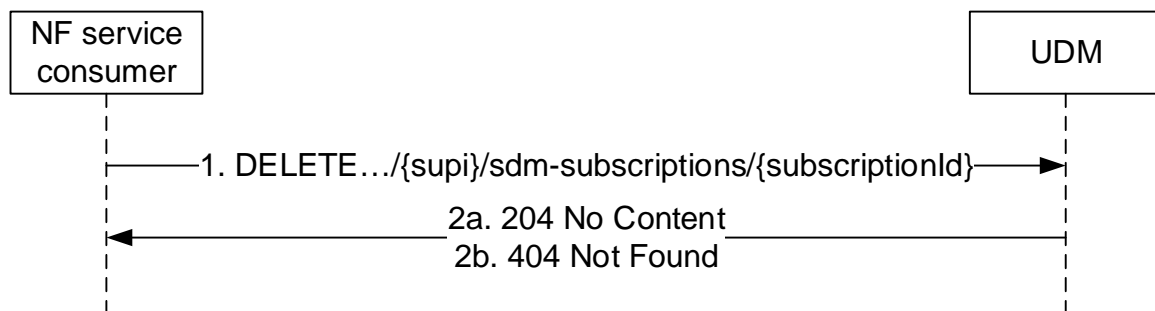

Figure 5.2.2.4.2-1: NF service consumer unsubscribes to notifications

1. The NF service consumer sends a DELETE request to the resource identified by the URI previously received during subscription creation.
- 2a. On success, the UDM responds with "204 No Content".
- 2b. If there is no valid subscription available (e.g. due to an unknown subscriptionId value), HTTP status code "404 Not Found" should be returned including additional error information in the response body (in the "ProblemDetails" element).

5.2.2.5 Notification

5.2.2.5.1 General

The following procedures using the Notification service operation are supported:

- Data change notification to NF

5.2.2.5.2 Data Change Notification To NF

Figure 5.2.2.5.2-1 shows a scenario where the UDM notifies the NF service consumer (that has subscribed to receive such notification) about subscription data change (see also 3GPP TS 23.502 [3] clause 4.5.2). The request contains the callbackReference URI as previously received in the SdmSubscription (see subclause 6.1.6.2.3).

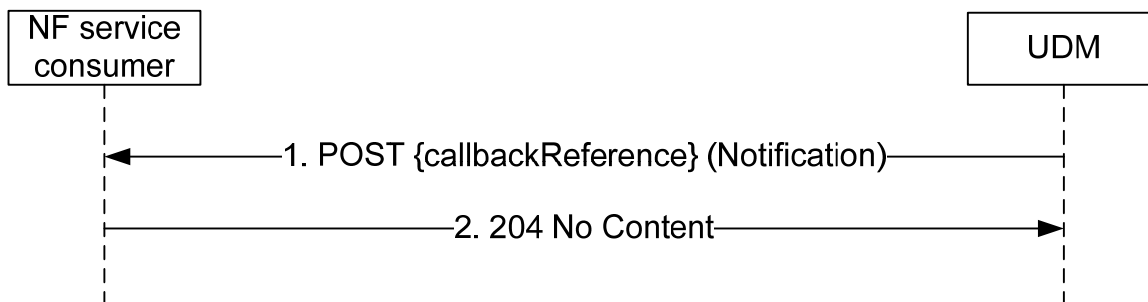

Figure 5.2.2.5.2-1: Subscription Data Change Notification

1. The UDM sends a POST request to the callbackReference as provided by the NF service consumer during the subscription.
2. The NF service consumer responds with "204 No Content".

5.3 Nudm_UEContextManagement Service

5.3.1 Service Description

See 3GPP TS 23.501 [2] table 7.2.5-1.

5.3.2 Service Operations

5.3.2.1 Introduction

For the Nudm_UEContextManagement service the following service operations are defined:

- Registration
- DeregistrationNotification
- Deregistration
- Get
- Update
- P-CSCF-RestorationNotification

The Nudm_UEContextManagement Service is used by Consumer NFs (AMF, SMS, SMSF) to register at the UDM by means of the Registration service operation.

It is also used by the registered Consumer NFs (AMF) to get notified by means of the DeregistrationNotification service operation when UDM decides to deregister the registered consumer NF.

It is also used by the registered Consumer NFs (AMF, SMF, SMSF) to deregister from the UDM by means of the Deregistration service operation.

It is also used by consumer NFs (NEF) to retrieve registration information from the UDM by means of the Get service operation.

It is also used by the registered Consumer NFs (AMF, SMF) to update registration information stored at the UDM by means of the Update service operation.

It is also used by the registered Consumer NFs (AMF, SMF) to get notified by means of the P-CSCF-RestorationNotification service operation when UDM detects the need for P-CSCF restoration.

5.3.2.2 Registration

5.3.2.2.1 General

The Registration service operation is invoked by a NF that has been selected to provide service to the UE to store related UE Context Management information in UDM.

NF Consumers are AMF for access and mobility management service, SMF for session management services and SMSF providing SMS services.

As part of this registration procedure, the UDM authorizes or rejects the subscriber to use the service provided by the registered NF, based on subscription data (e.g. roaming restrictions).

The following procedures using the Registration service operation are supported:

- AMF registration for 3GPP access
- AMF registration for non-3GPP access
- SMF registration
- SMSF registration for 3GPP access
- SMSF registration for non-3GPP access

5.3.2.2.2 AMF registration for 3GPP access

Figure 5.3.2.2.2-1 shows a scenario where the AMF sends a request to the UDM to update the AMF registration information for 3GPP access (see also 3GPP TS 23.502 [3] figure 4.2.2.2.2-1 step 14). The request contains the UE's identity ($\{ueId\}$) which shall be a SUPI and the AMF Registration Information for 3GPP access.

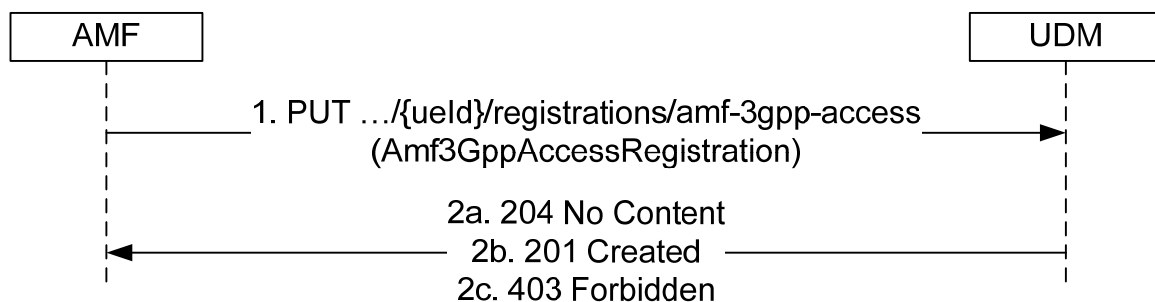

Figure 5.3.2.2.2-1: AMF registering for 3GPP access

1. The AMF sends a PUT request to the resource representing the UE's AMF registration for 3GPP access to update or create AMF registration information.
- 2a. On success, and if another AMF is registered for 3GPP access, the UDM updates the Amf3GppAccessRegistration resource by replacing it with the received resource information, and responds with "204 No Content".

UDM shall invoke the Deregistration Notification service operation towards the old AMF using the callback URI provided by the old AMF.
- 2b. If the resource does not exist (there is no previous AMF information stored in UDM for that user), UDM stores the received AMF registration data for 3GPP access and responds with HTTP Status Code "201 created". A response body may be included to convey additional information to the NF consumer (e.g., features supported by UDM).
- 2c. If the operation cannot be authorized due to e.g. UE does not have required subscription data, access barring or roaming restrictions, HTTP status code "403 Forbidden" should be returned including additional error information in the response body (in "ProblemDetails" element).

5.3.2.2.3 AMF registration for non 3GPP access

Figure 5.3.2.2.3-1 shows a scenario where the AMF sends a request to the UDM to update the AMF registration information for non 3GPP access (see also 3GPP TS 23.502 [3] figure 4.2.2.2.2-1 step 14). The request contains the UE's identity ($\{ueId\}$) which shall be a SUPI and the AMF Registration Information for non 3GPP access.

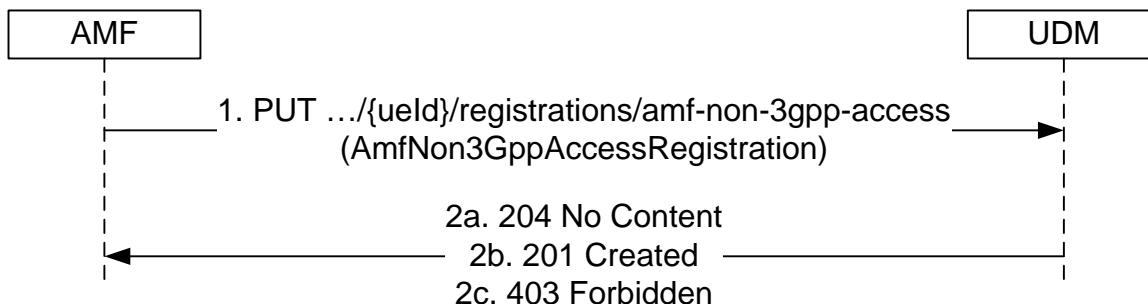

Figure 5.3.2.2.3-1: AMF registering for non 3GPP access

1. The AMF sends a PUT request to the resource representing the UE's AMF registration for non 3GPP access to update or create AMF registration information.
- 2a. On success, and if another AMF is registered for non-3GPP access, the UDM updates the AmfNon3GppAccessRegistration resource by replacing it with the received resource information, and responds with "204 No Content".

UDM shall invoke the Deregistration Notification service operation towards the old AMF using the callback URI provided by the old AMF.

- 2b. If the resource does not exist (there is no previous AMF information stored in UDM for that user), UDM stores the received AMF registration data for non-3GPP access and responds with HTTP Status Code "201 created". A response body may be included to convey additional information to the NF consumer (e.g., features supported by UDM).
- 2c. If the operation cannot be authorized due to e.g. UE does not have required subscription data, access barring or roaming restrictions, HTTP status code "403 Forbidden" should be returned including additional error information in the response body (in the "ProblemDetails" element).

5.3.2.2.4 SMF registration

Figure 5.3.2.2.4-1 shows a scenario where an SMF sends a request to the UDM to create a new registration (see also 3GPP TS 23.502 [3] figure 4.3.2.2.1-1 step 4). The request contains the UE's identity ($\{ueId\}$) which shall be a SUPI and the SMF Registration Information.

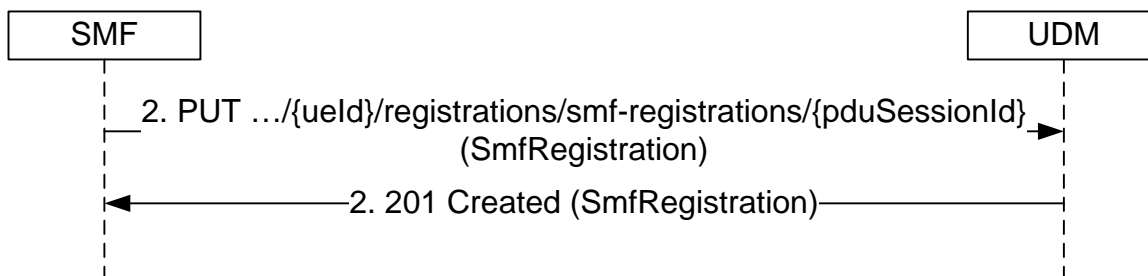

Figure 5.3.2.2.4-1: SMF registration

1. The SMF sends a PUT request to the resource $\dots\{ueId\}/registrations/smf-registrations/\{pduSessionId\}$, to create an SMF Registration as present in the message body.
2. The UDM responds with "201 Created" with the message body containing a representation of the created SMF registration.

5.3.2.2.5 SMSF Registration for 3GPP Access

Figure 5.3.2.2.5-1 shows a scenario where the SMSF sends a request to the UDM to create or update the SMSF registration information for 3GPP access (see also 3GPP TS 23.502 [3], section 4.13.3.1). The request contains the UE's identity ($\{ueId\}$) which shall be a SUPI and the SMSF Registration Information for SMS service.

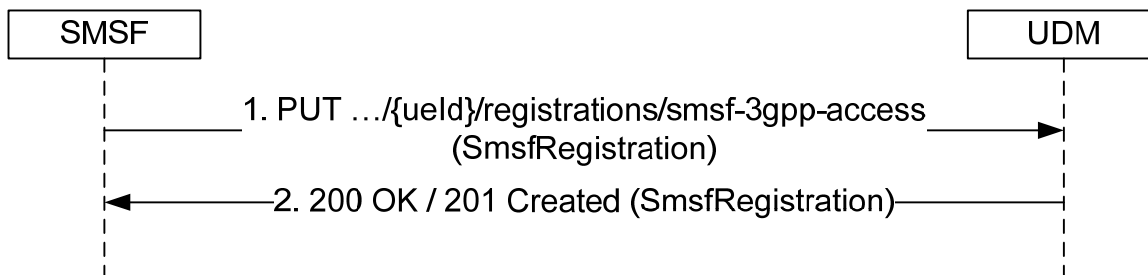

Figure 5.3.2.2.5-1: SMSF registering for 3GPP Access

1. The SMSF sends a PUT request to the resource representing the UE's SMSF registration for 3GPP Access to update or create SMSF registration information.
2. If successful, the UDM responds with "200 OK", or "201 Created" with the message body containing the representation of the `SmsfRegistration`.

On failure, the appropriate HTTP status code indicating the error shall be returned and appropriate additional error information should be returned in the PUT response body.

5.3.2.2.6 SMSF Registration for Non 3GPP Access

Figure 5.3.2.2.6-1 shows a scenario where the SMSF sends a request to the UDM to create or update the SMSF registration information for non 3GPP access (see also 3GPP TS 23.502 [3], section 4.13.3.1). The request contains the UE's identity ($\{ueId\}$) which shall be a SUPI and the SMSF Registration Information for SMS service.

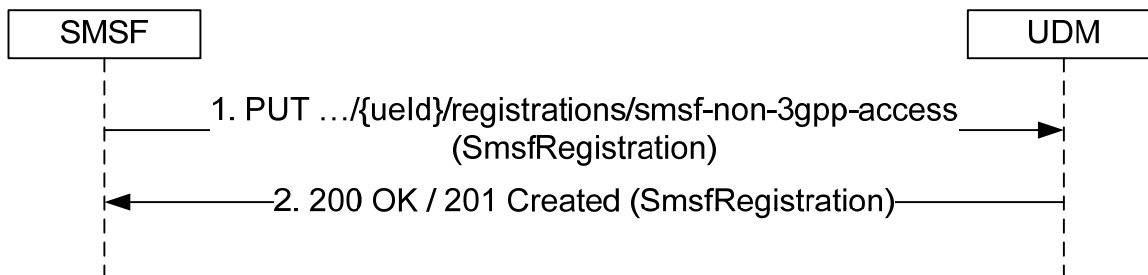

Figure 5.3.2.2.6-1: SMSF registering for Non 3GPP Access

1. The SMSF sends a PUT request to the resource representing the UE's SMSF registration for Non 3GPP Access to update or create SMSF registration information.
2. If successful, the UDM responds with "200 OK", or "201 Created" with the message body containing the representation of the `SmsfRegistration`.

On failure, the appropriate HTTP status code indicating the error shall be returned and appropriate additional error information should be returned in the PUT response body.

5.3.2.3 DeregistrationNotification

5.3.2.3.1 General

The following procedure using the DeregistrationNotification service operation is supported:

- UDM initiated NF Deregistration

5.3.2.3.2 UDM initiated NF Deregistration

Figure 5.3.2.3.2-1 shows a scenario where the UDM notifies the registered NF about its deregistration (see also 3GPP TS 23.502 [3] figure 4.2.2.2-1 step 14). The request contains the callback URI for deregistration notification as received by the UDM during registration, and Deregistration Data.

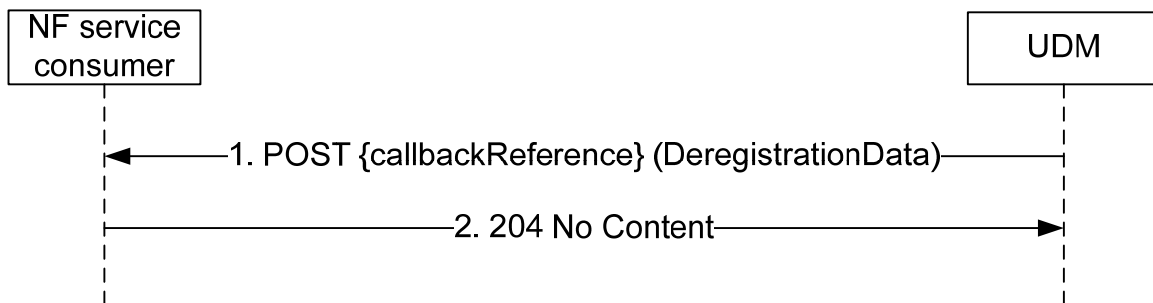

Figure 5.3.2.3.2-1: UDM initiated NF Deregistration

1. The UDM sends a POST request to the callbackReference as provided by the NF service consumer during the registration.
2. The NF service consumer responds with "204 No Content".

5.3.2.4 Deregistration

5.3.2.4.1 General

The following procedures using the Deregistration service operation are supported:

- AMF deregistration for 3GPP access
- AMF deregistration for non-3GPP access
- SMF deregistration
- SMSF deregistration for 3GPP access
- SMSF deregistration for non-3GPP access

5.3.2.4.2 AMF deregistration for 3GPP access

Figure 5.3.2.4.2-1 shows a scenario where the AMF sends a request to the UDM to deregister (purge) from the UDM for 3GPP access (see also 3GPP TS 23.502 [3] figure 4.5.3.1-1 step 3). The request contains the UE's identity ($\{ueId\}$) which shall be a SUPI and an instruction to set the purgeFlag within the Amf3GppAccessRegistration resource.

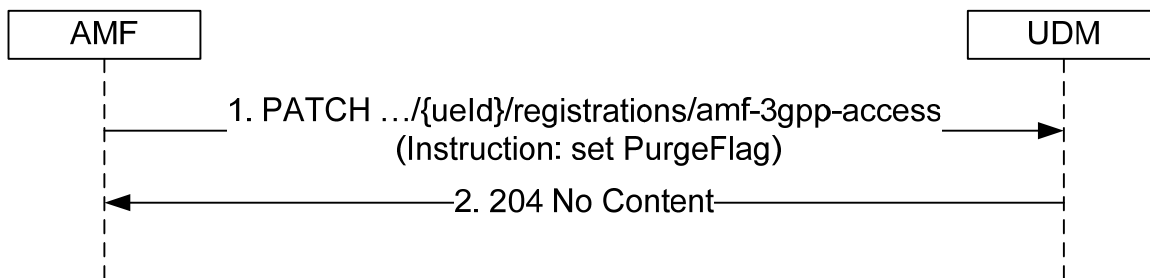

Figure 5.3.2.4.2-1: AMF deregistering for 3GPP access

1. The AMF sends a PATCH request to the resource representing the UE's AMF registration for 3GPP access.
2. The UDM responds with "204 No Content".

5.3.2.4.3 AMF deregistration for non-3GPP access

Figure 5.3.2.4.3-1 shows a scenario where the AMF sends a request to the UDM to deregister (purge) from the UDM for non-3GPP access (see also 3GPP TS 23.502 [3] figure 4.5.3.1-1 step 3). The request contains the UE's identity (/ {ueId}) which shall be a SUPI and an instruction to set the purgeFlag within the AmfNon3GppAccessRegistration resource.

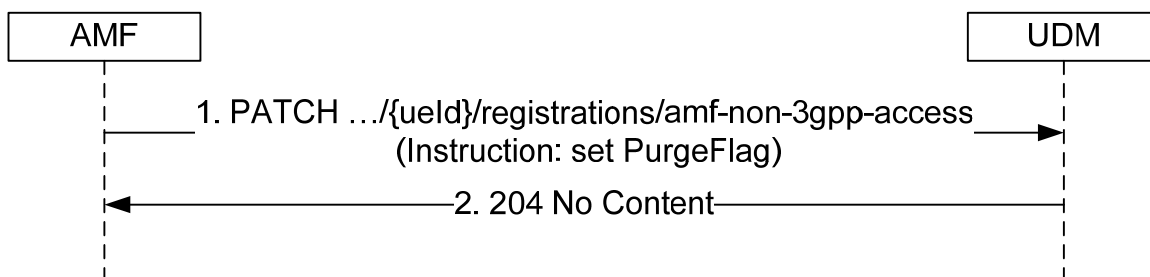

Figure 5.3.2.4.3-1: AMF deregistering for non-3GPP access

1. The AMF sends a PATCH request to the resource representing the UE's AMF registration for non-3GPP access.
2. The UDM responds with "204 No Content".

5.3.2.4.4 SMF deregistration

Figure 5.3.2.4.4-1 shows a scenario where the SMF sends a request to the UDM to deregister an individual SMF registration (see also 3GPP TS 23.502 [3] figure 4.3.2.2-1 step 20). The request contains the UE's identity (/ {ueId}) which shall be a SUPI and the PDU Session ID (/ {pduSessionId}).

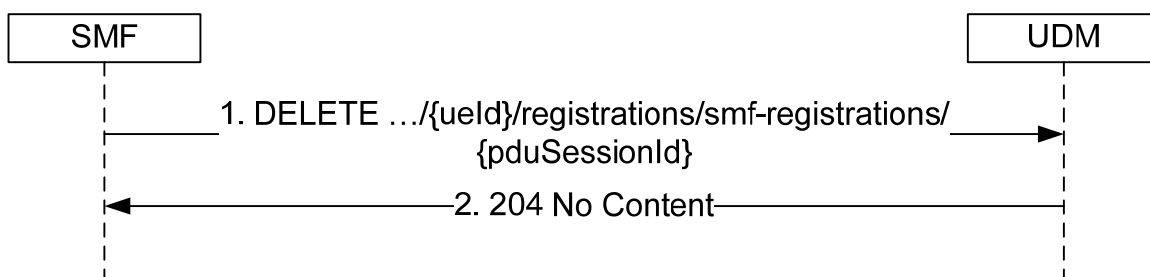

Figure 5.3.2.4.4-1: SMF deregistration

1. The SMF sends a DELETE request to the resource representing the individual SMF registration that is to be deregistered.
2. The UDM responds with "204 No Content".

5.3.2.4.5 SMSF Deregistration for 3GPP Access

Figure 5.3.2.4.5-1 shows a scenario where the SMSF sends a request to the UDM to delete the SMSF registration information for 3GPP access (see also 3GPP TS 23.502 [3], section 4.13.3.2). The request contains the UE's identity ($\{ueId\}$) which shall be a SUPI.

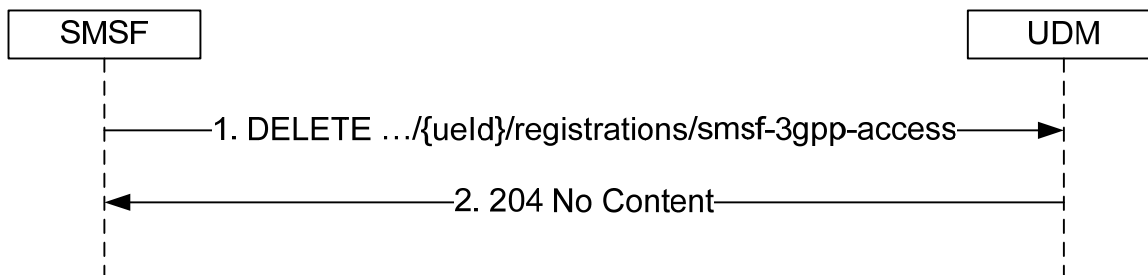

Figure 5.3.2.4.5-1: SMSF Deregistering for 3GPP Access

1. The SMSF sends a DELETE request to the resource representing the UE's SMSF registration for 3GPP access.
2. If successful, the UDM responds with "204 No Content".

On failure, the appropriate HTTP status code indicating the error shall be returned and appropriate additional error information should be returned in the DELETE response body.

5.3.2.4.6 SMSF Deregistration for Non 3GPP Access

Figure 5.3.2.4.6-1 shows a scenario where the SMSF sends a request to the UDM to delete the SMSF registration information for non 3GPP access (see also 3GPP TS 23.502 [3], section 4.13.3.2). The request contains the UE's identity ($\{ueId\}$) which shall be a SUPI.

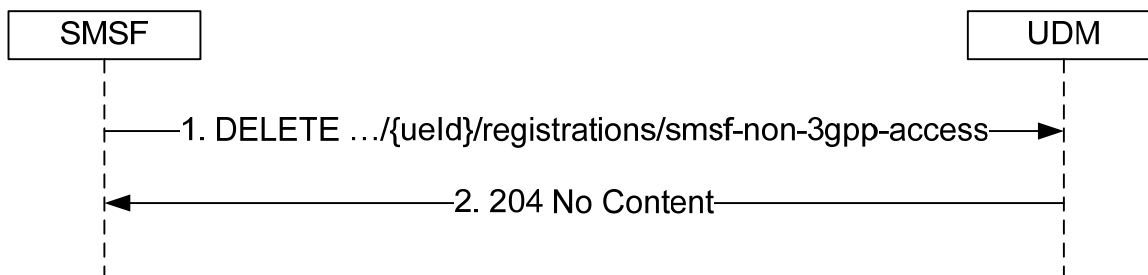

Figure 5.3.2.4.6-1: SMSF Deregistering for Non 3GPP Access

1. The SMSF sends a DELETE request to the resource representing the UE's SMSF registration for non 3GPP access.
2. If successful, the UDM responds with "204 No Content".

On failure, the appropriate HTTP status code indicating the error shall be returned and appropriate additional error information should be returned in the DELETE response body.

5.3.2.5 Get

5.3.2.5.1 General

The following procedures using the Get service operation are supported:

- Amf3GppAccessRegistration Information Retrieval

- AmfNon3GppAccessRegistration Information Retrieval
- SmfRegistrations Information Retrieval
- SmsfRegistration Information Retrieval for 3GPP Access
- SmsfRegistration Information Retrieval for Non-3GPP Access

5.3.2.5.2 Amf3GppAccessRegistration Information Retrieval

Figure 5.3.2.5.2-1 shows a scenario where the NF service consumer (e.g. NEF) sends a request to the UDM to retrieve the UE's Amf3GppAccessRegistration Information. The request contains the UE's identity ($\{ueId\}$) which shall be a GPSI, the type of the requested information ($/registration/amf-3gpp-access$) and query parameters (supportedFeatures).

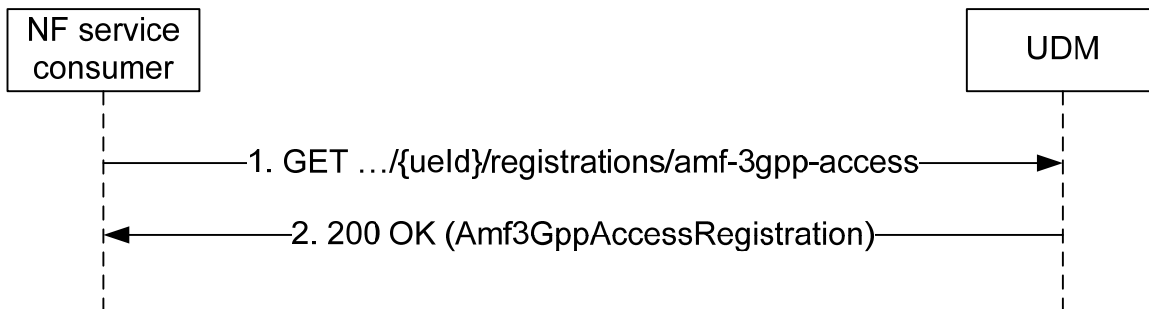

Figure 5.3.2.5.2-1: Requesting a UE's AMF Registration Information for 3GPP Access

1. The NF service consumer (e.g. NEF) sends a GET request to the resource representing the UE's AMF registration information for 3GPP access, with query parameters indicating the supportedFeatures.
2. The UDM responds with "200 OK" with the message body containing the UE's Amf3GppAccessRegistration.

5.3.2.5.3 AmfNon3GppAccessRegistration Information Retrieval

Figure 5.3.2.5.3-1 shows a scenario where the NF service consumer (e.g. NEF) sends a request to the UDM to retrieve the UE's AmfNon3GppAccessRegistration Information. The request contains the UE's identity ($\{ueId\}$) which shall be a GPSI, the type of the requested information ($/registration/amf-non-3gpp-access$) and query parameters (supportedFeatures).

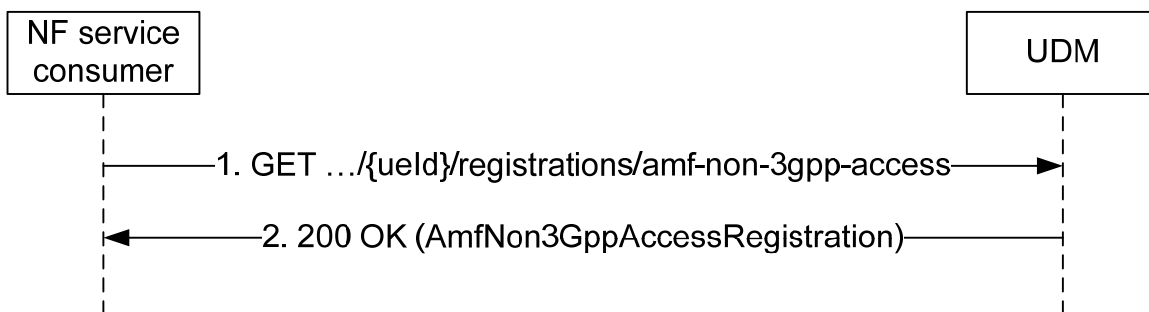

Figure 5.3.2.5.3-1: Requesting a UE's AMF Registration Information for non-3GPP Access

1. The NF service consumer (e.g. NEF) sends a GET request to the resource representing the UE's AMF registration information for non-3GPP access, with query parameters indicating the supportedFeatures.
2. The UDM responds with "200 OK" with the message body containing the UE's AmfNon3GppAccessRegistration.

5.3.2.5.4 SmfRegistrations Information Retrieval

tbd

5.3.2.5.5 SmsfRegistration Information Retrieval for 3GPP Access

Figure 5.3.2.5.5-1 shows a scenario where the NF service consumer (e.g. NEF) sends a request to the UDM to retrieve the UE's SmsfRegistration Information. The request contains the UE's identity ($\{ueId\}$) which shall be a GPSI, the type of the requested information ($/registrations/smsf-3gpp-access$) and query parameters (supported-features).

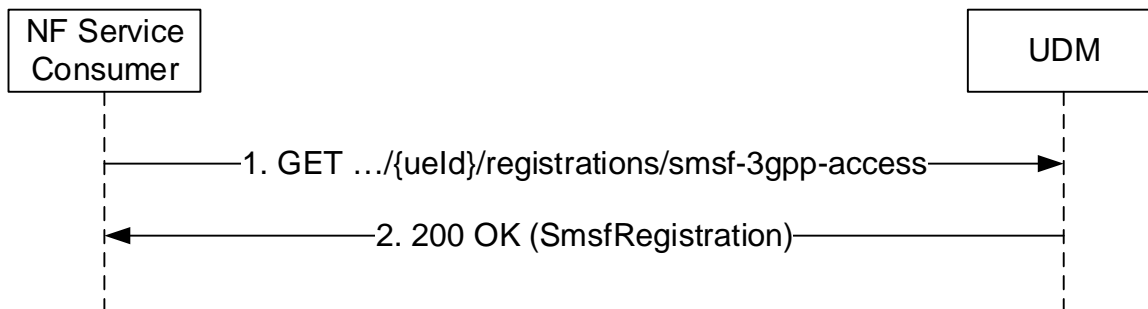

Figure 5.3.2.5.5-1: Requesting a UE's SMSF Registration Information for 3GPP Access

1. The NF service consumer (e.g. NEF) sends a GET request to the resource representing the UE's SMSF registration information for 3GPP access, with query parameters indicating the supported-features.
2. The UDM responds with "200 OK" with the message body containing the UE's SmsfRegistration for 3GPP access.

5.3.2.5.6 SmsfRegistration Information Retrieval for Non-3GPP Access

Figure 5.3.2.5.6-1 shows a scenario where the NF service consumer (e.g. NEF) sends a request to the UDM to retrieve the UE's SmsfRegistration Information for non-3GPP access. The request contains the UE's identity ($\{ueId\}$) which shall be a GPSI, the type of the requested information ($/registrations/smsf-non-3gpp-access$) and query parameters (supported-features).

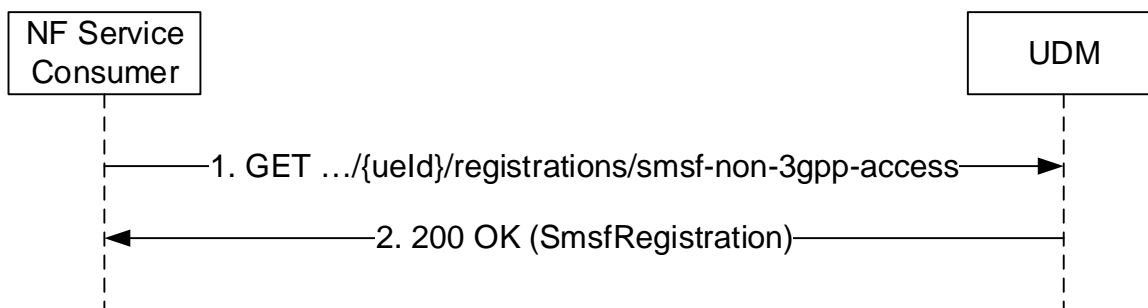

Figure 5.3.2.5.6-1: Requesting a UE's SMSF Registration Information for Non-3GPP Access

1. The NF service consumer (e.g. NEF) sends a GET request to the resource representing the UE's SMSF registration information for non-3GPP access, with query parameters indicating the supported-features.
2. The UDM responds with "200 OK" with the message body containing the UE's SmsfRegistration for non-3GPP access.

5.3.2.6 Update

5.3.2.6.1 General

The following procedures using the Update service operation are supported:

- Update a parameter (e.g. PEI) in the AMF registration for 3GPP access
- Update a parameter (e.g. PEI) in the AMF registration for non-3GPP access

5.3.2.6.2 Update A Parameter (e.g. PEI) in the AMF Registration For 3GPP Access

Figure 5.3.2.6.2-1 shows a scenario where the AMF sends a request to the UDM to update a parameter within the `Amf3GppAccessRegistration` resource. The request contains the UE's identity (`/ueId`) which shall be a SUPI and an instruction to modify a parameter (e.g. PEI).

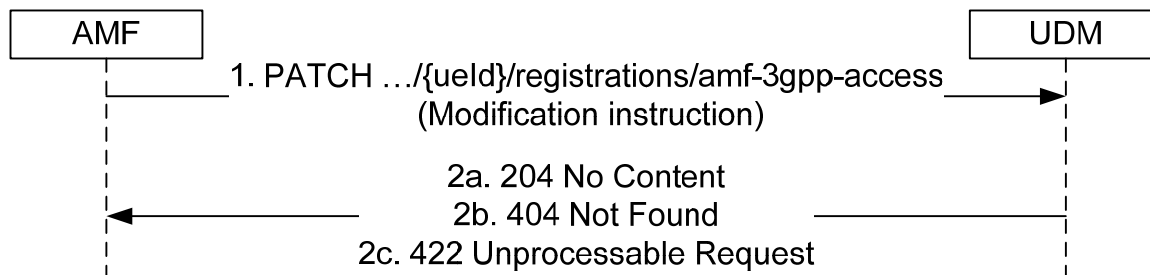

Figure 5.3.2.6.2-1: AMF registration parameter update for 3GPP access

1. The AMF sends a PATCH request to the resource representing the UE's AMF registration for 3GPP access.
- 2a. On success, the UDM responds with "204 No Content".
- 2b. If the resource does not exist e.g. the UE is not registered yet, HTTP status code "404 Not Found" should be returned including additional error information in the response body (in the "ProblemDetails" element).
- 2c. If the resource exists, but the requesting AMF is not the one currently registered for the UE, HTTP status code "422 Unprocessable Request" should be returned including additional error information in the response body (in the "ProblemDetails" element).

5.3.2.6.3 Update A Parameter (e.g. PEI) in the AMF Registration For Non 3GPP Access

Figure 5.3.2.6.3-1 shows a scenario where the AMF sends a request to the UDM to update a parameter within the `AmfNon3GppAccessRegistration` resource. The request contains the UE's identity (`/ueId`) which shall be a SUPI and an instruction to modify a parameter (e.g. PEI).

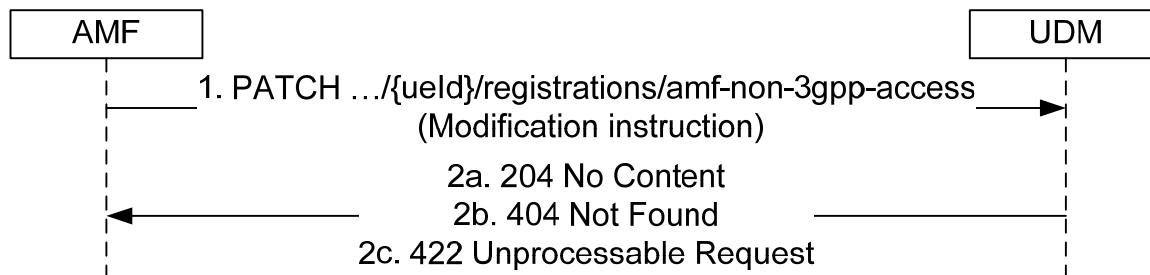

Figure 5.3.2.6.3-1: AMF registration parameter update for non-3GPP access

1. The AMF sends a PATCH request to the resource representing the UE's AMF registration for non-3GPP access.
- 2a. On success, the UDM responds with "204 No Content".
- 2b. If the resource does not exist e.g. the UE is not registered yet, HTTP status code "404 Not Found" should be returned including additional error information in the response body (in the "ProblemDetails" element).
- 2c. If the resource exists, but the requesting AMF is not the one currently registered for the UE, HTTP status code "422 Unprocessable Request" should be returned including additional error information in the response body (in the "ProblemDetails" element).

5.3.2.7 P-CSCF-RestorationNotification

5.3.2.7.1 General

The following procedure using the P-CSCF-RestorationNotification service operation is supported:

- UDM initiated P-CSCF-Restoration

5.3.2.7.2 UDM initiated P-CSCF-Restoration

Figure 5.3.2.7.2-1 shows a scenario where the UDM notifies the registered AMF or SMF about the need for P-CSCF restoration. The request contains the callback URI for P-CSCF restoration as received by the UDM during registration, and P-CSCF Restoration Indication.

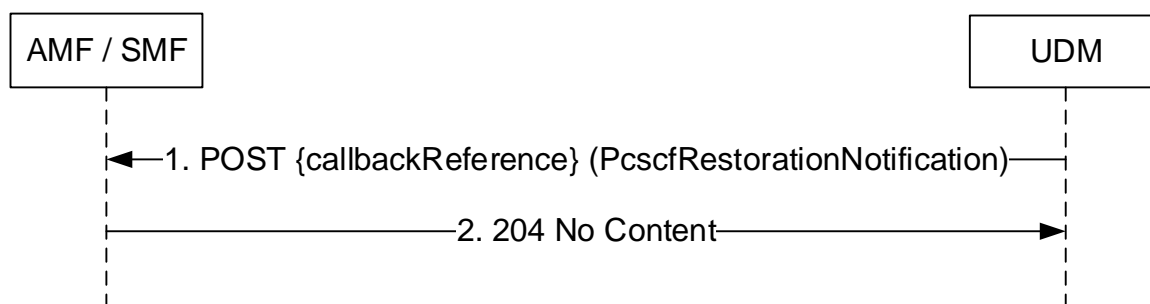

Figure 5.3.2.7.2-1: UDM initiated P-CSCF Restoration

1. The UDM sends a POST request to the callbackReference as provided by the NF service consumer during the registration.
2. The AMF or SMF responds with "204 No Content".

5.4 Nudm_UEAuthentication Service

5.4.1 Service Description

See 3GPP TS 23.501 [2] table 7.2.5-1.

5.4.2 Service Operations

5.4.2.1 Introduction

For the Nudm_UEAuthentication service the following service operation is defined:

- Get
- ResultConfirmation

The Nudm_UEAuthentication service is used by the AUSF to request the UDM to select an authentication method, calculate a fresh authentication vector (AV) if required for the selected method, and provide it to the AUSF by means of the Get service operation. See 3GPP TS 33.501 [6] subclause 9.7.2.1.

The Nudm_UEAuthentication service is also used by the AUSF to inform the UDM about the occurrence of a successful or unsuccessful authentication by means of the ResultConfirmation service operation. See 3GPP TS 33.501 [6] subclause 9.7.3.1.

5.4.2.2 Get

5.4.2.2.1 General

The following procedure using the Get service operation is supported:

- Authentication Information Retrieval

5.4.2.2.2 Authentication Information Retrieval

Figure 5.4.2.2.2-1 shows a scenario where the NF service consumer (AUSF) retrieves authentication information for the UE from the UDM (see also 3GPP TS 33.501 [6] subclause 6.1.2). The request contains the UE's identity (supi or suci), the serving network name, and may contain resynchronization info.

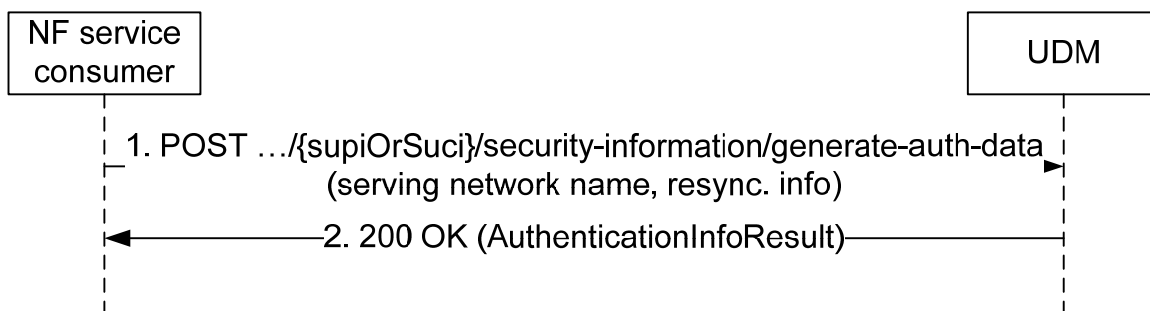

Figure 5.4.2.2.2-1: NF service consumer requesting authentication information

1. The NF service consumer sends a POST request (custom method: generate-auth-data) to the resource representing the UE's security information.
2. The UDM responds with "200 OK" with the message body containing the authentication data information.

5.4.2.3 ResultConfirmationInform

5.4.2.3.1 General

The following procedure using the ResultConfirmation service operation is supported:

- Authentication Confirmation

5.4.2.3.2 Authentication Confirmation

Figure 5.4.2.3.2-1 shows a scenario where the NF service consumer (AUSF) confirms the occurrence of a successful or unsuccessful authentication to the UDM (see also 3GPP TS 33.501 [6] subclause 6.1.4.1). The request contains the UE's identity (supi), and information about the authentication occurrence (AuthEvent).

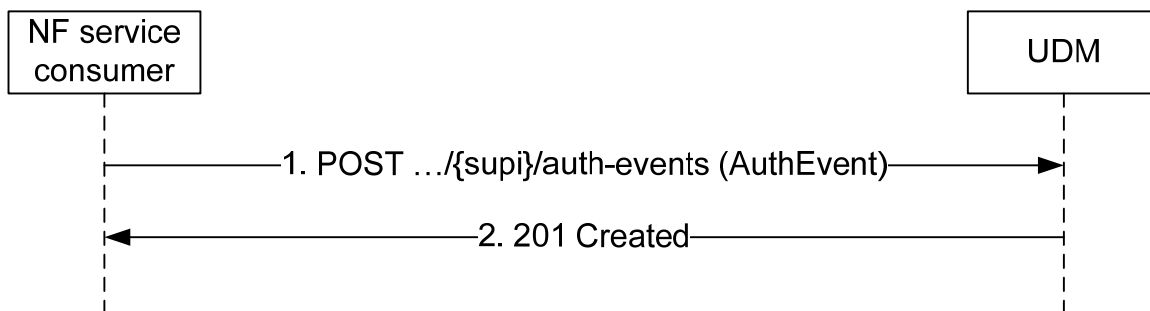

Figure 5.4.2.3.2-1: NF service consumer confirms UE authentication

1. The NF service consumer sends a POST request to the resource representing the UE's authentication events.

2. The UDM responds with "201 Created".

5.5 Nudm_EventExposure Service

5.5.1 Service Description

See 3GPP TS 23.501 [2] table 7.2.5-1.

5.5.2 Service Operations

5.5.2.1 Introduction

For the Nudm_EventExposure service the following service operations are defined:

- Subscribe
- Unsubscribe
- Notify

The Nudm_EventExposure service is used by consumer NFs (e.g. NEF) to subscribe to notifications of event occurrence by means of the Subscribe service operation. For events that can be detected by the AMF, the UDM makes use of the appropriate AMF service operation to subscribe on behalf of the consumer NF (e.g. NEF).

The Nudm_EventExposure service is also used by the consumer NFs (e.g. NEF) that have previously subscribed to notifications, to unsubscribe by means of the Unsubscribe service operation. For events that can be detected by the AMF, the UDM makes use of the appropriate AMF service operation to unsubscribe on behalf of the consumer NF (e.g. NEF).

The Nudm_EventExposure service is also used by the subscribed consumer NFs (e.g. NEF) to get notified by the UDM when a subscribed event occurs at the UDM by means of the Notify service operation. For subscribed events that can occur at the AMF, the consumer NF (e.g. NEF) makes use of the corresponding AMF service operation to get notified by the AMF directly without UDM involvement.

For details see 3GPP TS 23.502 [3] subclause 4.15.

5.5.2.2 Subscribe

5.5.2.2.1 General

The following procedures using the Subscribe service operation are supported:

- Subscribe to Notification of event occurrence

5.5.2.2.2 Subscription to Notification of event occurrence

Figure 5.5.2.2.2-1 shows a scenario where the NF service consumer sends a request to the UDM to subscribe to notifications of event occurrence (see also 3GPP TS 23.502 [3] figure 4.15.3.2.2-1 step 1). The request contains a callback URI, the type of event that is monitored and additional information e.g. event filters and reporting options.

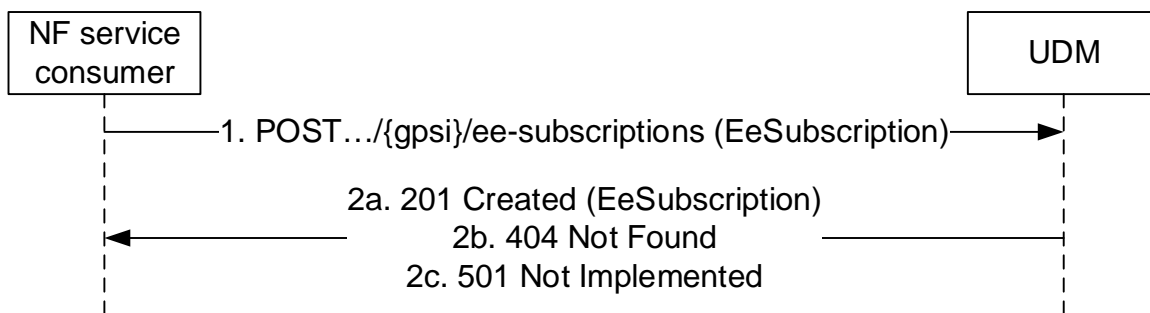

Figure 5.5.2.2.2-1: NF service consumer subscribes to notifications

1. The NF service consumer sends a POST request to the parent resource (collection of subscriptions) (.../{gpsi}/ee-subscriptions), to create a subscription as present in message body.
- 2a. On success, the UDM responds with "201 Created" with the message body containing a representation of the created subscription. The Location HTTP header shall contain the URI of the created subscription.
- 2b. If there is no valid subscription data for the UE, HTTP status code "404 Not Found" shall be returned including additional error information in the response body (in the "ProblemDetails" element).
- 2c. If the UE subscription data exist, but the requested event notification cannot be created (e.g. due to an invalid/unsupported monitoring EventType, contained in the MonitoringConfiguration attribute of EeSubscription), HTTP status code "501 Not Implemented" shall be returned including additional error information in the response body (in the "ProblemDetails" element).

5.5.2.3 Unsubscribe

5.5.2.3.1 General

The following procedures using the Unsubscribe service operation are supported:

- Unsubscribe to Notifications of event occurrence

5.5.2.3.2 Unsubscribe to notifications of event occurrence

Figure 5.2.2.4.2-1 shows a scenario where the NF service consumer sends a request to the UDM to unsubscribe from notifications of event occurrence. The request contains the URI previously received in the Location HTTP header of the response to the subscription.

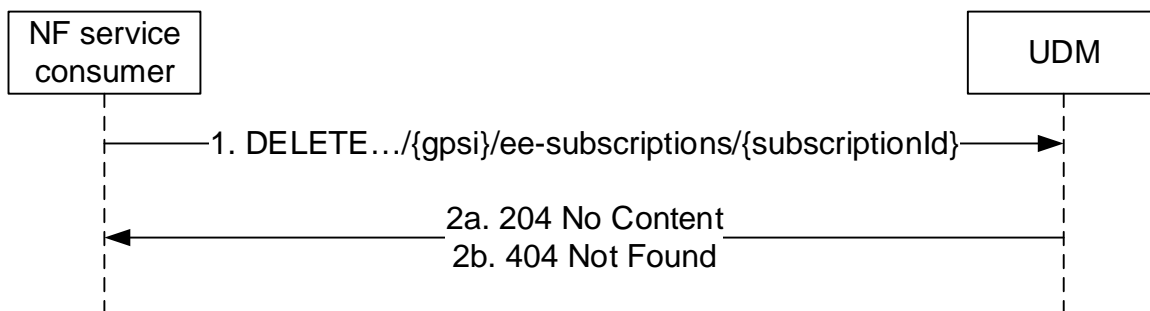

Figure 5.2.2.4.2-1: NF service consumer unsubscribes to notifications

1. The NF service consumer sends a DELETE request to the resource identified by the URI previously received during subscription creation.
- 2a. On success, the UDM responds with "204 No Content".
- 2b. If there is no valid subscription available (e.g. due to an unknown SubscriptionId value), HTTP status code "404 Not Found" shall be returned including additional error information in the response body (in the "ProblemDetails" element).

5.5.2.4 Notify

5.5.2.4.1 General

The following procedures using the Notify service operation are supported:

- Event Occurrence Notification

5.5.2.4.2 Event Occurrence Notification

Figure 5.5.2.4.2-1 shows a scenario where the UDM notifies the NF service consumer (that has subscribed to receive such notification) about occurrence of an event (see also 3GPP TS 23.502 [3] figure 4.15.3.2.2-1 step 4a). The request contains the callbackReference URI as previously received in the EeSubscription (see subclause 6.4.6.2.2).

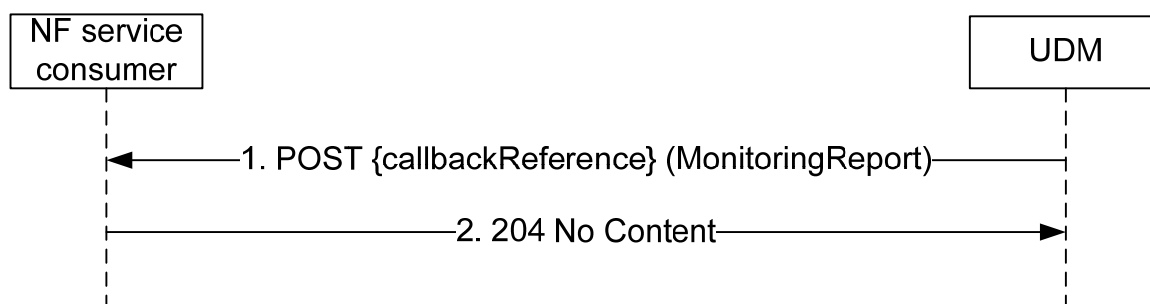

Figure 5.5.2.4.2-1: Event Occurrence Notification

1. The UDM sends a POST request to the callbackReference as provided by the NF service consumer during the subscription.
2. The UDM responds with "204 No Content".

5.6 Nudm_ParameterProvision Service

5.6.1 Service Description

See 3GPP TS 23.501 [2] table 7.2.5-1.

5.6.2 Service Operations

5.6.2.1 Introduction

For the Nudm_ParameterProvision service the following service operations are defined:

- Update

The Nudm_ParameterProvision service is used by consumer NFs (e.g. NEF) to update a UE's subscription data by means of the Update service operation.

For details see 3GPP TS 23.502 [3] subclause 4.15.6.2.

Editor's Note: It is ffs how the UDM can authorize Update requests

Editor's Note: A service operation for data retrieval is ffs

5.6.2.2 Update

5.6.2.2.1 General

The following procedures using the Update service operation are supported:

- Subscription data update

5.6.2.2.2 Subscription data update

Figure 5.6.2.2.2-1 shows a scenario where the NF service consumer sends a request to the UDM to update a UE's subscription data (see also 3GPP TS 23.502 [3] figure 4.15.6.2-1 step 2). The request contains the identifier of the UE's parameter provision data (`.../{gpsi}/pp-data`) and the modification instructions.

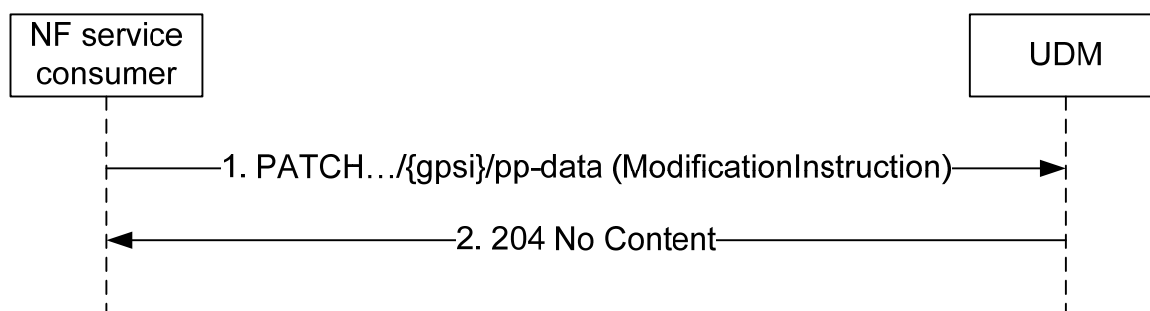

Figure 5.6.2.2.2-1: NF service consumer updates subscription data

1. The NF service consumer sends a PATCH request to the resource that represents a UE's modifiable subscription data.
2. The UDM responds with "204 No Content".

6 API Definitions

6.1 Nudm_SubscriberDataManagement Service API

6.1.1 API URI

URIs of this API shall have the following root:

```
{apiRoot}/{apiName}/{apiVersion}/
```

where the "apiName" shall be set to "nudm-sdm" and the "apiVersion" shall be set to "v1" for the current version of this specification.

6.1.2 Usage of HTTP

6.1.2.1 General

HTTP/2, as defined in IETF RFC 7540 [13], shall be used as specified in clause 5 of 3GPP TS 29.500 [4].

HTTP/2 shall be transported as specified in subclause 5.3 of 3GPP TS 29.500 [4].

HTTP messages and bodies for the Nudm_SDM service shall comply with the OpenAPI [14] specification contained in Annex A2.

6.1.2.2 HTTP standard headers

6.1.2.2.1 General

The usage of HTTP standard headers shall be supported as specified in subclause 5.2.2 of 3GPP TS 29.500 [4].

6.1.2.2.2 Content type

The following content types shall be supported:

JSON, as defined in IETF RFC 8259 [15], signalled by the content type "application/json".

The Problem Details JSON Object (IETF RFC 7807 [16] signalled by the content type "application/problem+json"

6.1.2.3 HTTP custom headers

6.1.2.3.1 General

The usage of HTTP custom headers shall be supported as specified in subclause 5.2.3 of 3GPP TS 29.500 [4].

6.1.3 Resources

6.1.3.1 Overview

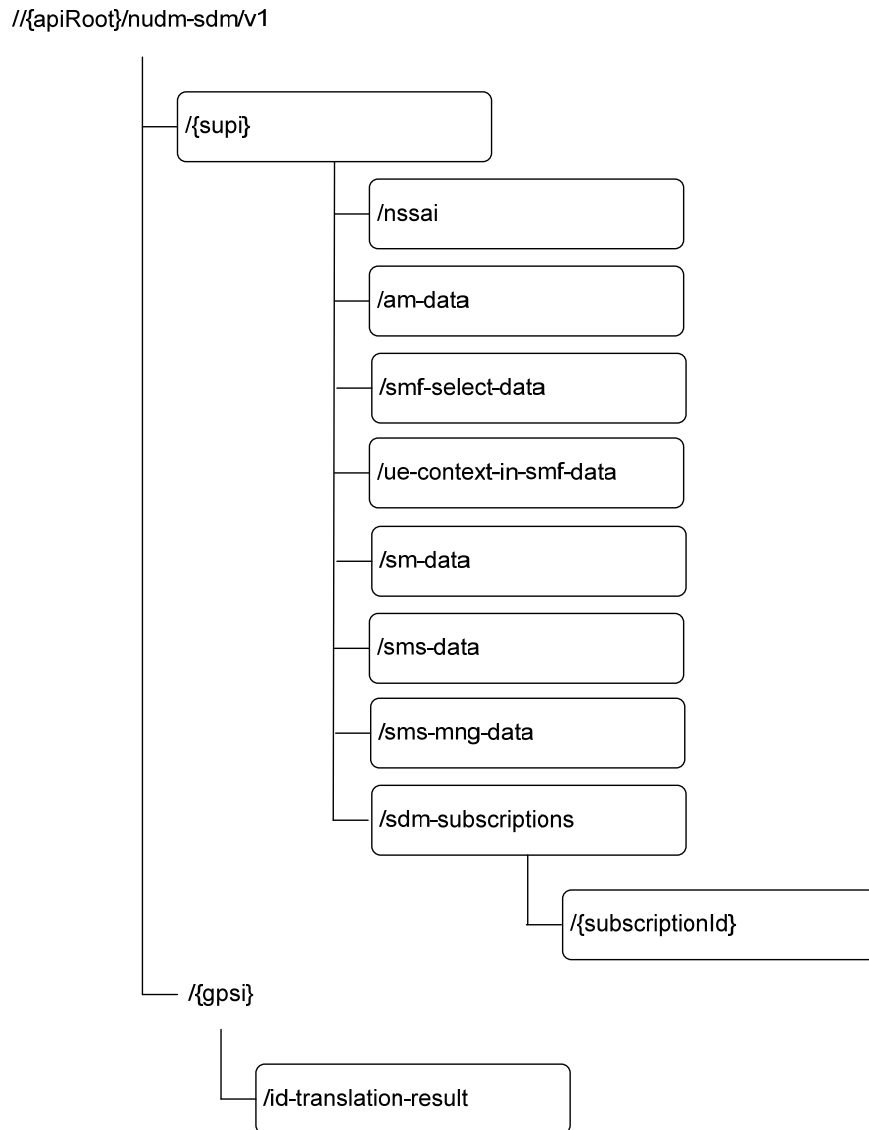

Figure 6.1.3.1-1: Resource URI structure of the nudm-sdm API

Table 6.1.3.1-1 provides an overview of the resources and applicable HTTP methods.

Table 6.1.3.1-1: Resources and methods overview

Resource name (Archetype)	Resource URI	HTTP method or custom operation	Description
Supi (Document)	/ {supi}	GET	Retrieve UE's subscription data
Nssai (Document)	/ {supi}/nssai	GET	Retrieve the UE's subscribed Network Slice Selection Assistance Information
AccessAndMobilitySubscriptionData (Document)	/ {supi}/am-data	GET	Retrieve the UE's subscribed Access and Mobility Data
SmfSelectionSubscriptionData (Document)	/ {supi}/smf-select-data	GET	Retrieve the UE's subscribed SMF Selection Data
UeContextInSmfData (Document)	/ {supi}/ue-context-in-smf-data	GET	Retrieve the UE's Context in SMF Data
SessionManagementSubscriptionData (Document)	/ {supi}/sm-data	GET	Retrieve the UE's session management subscription data
SMSSubscriptionData (Document)	/ {supi}/sms-data	GET	Retrieve the UE's SMS subscription data
SMSManagementSubscriptionData (Document)	/ {supi}/sms-mng-data	GET	Retrieve the UE's SMS management subscription data
SdmSubscriptions (Collection)	/ {supi}/sdm-subscriptions	POST	Create a subscription
Individual subscription (Document)	/ {supi}/sdm-subscriptions/ {subscriptionId}	DELETE	Delete the subscription identified by {subscriptionId}, i.e. unsubscribe
IdTranslationResult (Document)	/ {gpsi}/id-translation-result	GET	Retrieve a UE's SUPI

6.1.3.2 Resource: Nssai

6.1.3.2.1 Description

This resource represents the subscribed Nssai for a SUPI. It is queried by the AMF before registering, and is used to assist network slice selection. See 5.2.2.2.2 and 3GPP TS 23.501 [2] clause 5.15.3.

6.1.3.2.2 Resource Definition

Resource URI: {apiRoot}/nudm-sdm/v1/ {supi}/nssai

This resource shall support the resource URI variables defined in table 6.1.3.2.2-1.

Table 6.1.3.2.2-1: Resource URI variables for this resource

Name	Definition
apiRoot	See subclause 6.1.1
supi	Represents the Subscription Permanent Identifier (see 3GPP TS 23.501 [2] clause 5.9.2) pattern: "(imsi-[0-9]{5,15}nai-.+.+)"

6.1.3.2.3 Resource Standard Methods

6.1.3.2.3.1 GET

This method shall support the URI query parameters specified in table 6.1.3.2.3.1-1.

Table 6.1.3.2.3.1-1: URI query parameters supported by the GET method on this resource

Name	Data type	P	Cardinality	Description
supportedFeatures	SupportedFeatures	O	0..1	see 3GPP TS 29.500 [4] subclause 6.6
plmn-id	PlmnId	O	0..1	PLMN identity of the PLMN serving the UE

If "plmn-id" is included, UDM shall return the Subscribed S-NSSAIs which the UE is subscribed to use in the PLMN identified by "plmn-id".

If "plmn-id" is not included, UDM shall return the Subscribed S-NSSAIs for HPLMN.

This method shall support the request data structures specified in table 6.1.3.2.3.1-2 and the response data structures and response codes specified in table 6.1.3.2.3.1-3.

Table 6.1.3.2.3.1-2: Data structures supported by the GET Request Body on this resource

Data type	P	Cardinality	Description
n/a			

Table 6.1.3.2.3.1-3: Data structures supported by the GET Response Body on this resource

Data type	P	Cardinality	Response codes	Description
Nssai	M	1	200 OK	Upon success, a response body containing the NSSAI shall be returned.
NOTE: In addition common data structures as listed in table 6.1.7-1 are supported.				

6.1.3.3 Resource: SdmSubscriptions

6.1.3.3.1 Description

This resource is used to represent subscriptions to notifications.

6.1.3.3.2 Resource Definition

Resource URI: {apiRoot}/nudm-sdm/v1/{supi}/sdm-subscriptions

This resource shall support the resource URI variables defined in table 6.1.3.3.2-1.

Table 6.1.3.3.2-1: Resource URI variables for this resource

Name	Definition
apiRoot	See subclause 6.1.1
supi	Represents the Subscription Permanent Identifier (see 3GPP TS 23.501 [2] clause 5.9.2) pattern: "(imsi-[0-9]{5,15})nai-+.+)"

6.1.3.3.3 Resource Standard Methods

6.1.3.3.3.1 POST

This method shall support the URI query parameters specified in table 6.1.3.3.3.1-1.

Table 6.1.3.3.3.1-1: URI query parameters supported by the POST method on this resource

Name	Data type	P	Cardinality	Description
n/a				

This method shall support the request data structures specified in table 6.1.3.3.3.1-2 and the response data structures and response codes specified in table 6.1.3.3.3.1-3.

Table 6.1.3.3.3.1-2: Data structures supported by the POST Request Body on this resource

Data type	P	Cardinality	Description
SdmSubscription	M	1	The subscription that is to be created.

Table 6.1.3.3.3.1-3: Data structures supported by the POST Response Body on this resource

Data type	P	Cardinality	Response codes	Description
SdmSubscription	M	1	201 Created	Upon success, a response body containing a representation of the created Individual subscription resource shall be returned. The HTTP response shall include a "Location" HTTP header that contains the resource URI of the created resource. When stateless UDM is deployed, the stateless UDM shall use the FQDN identifying the UDM set to which the UDM belongs as the host part of the resource URI.

NOTE: In addition common data structures as listed in table 6.1.7-1 are supported.

NOTE: In the scenario of stateless UDM deployment, it is assumed that stateless UDMs are organized into several UDM sets, and each UDM set is allocated an FQDN.

6.1.3.4 Resource: Individual subscription

6.1.3.4.1 Description

This resource is used to represent an individual subscription to notifications.

6.1.3.4.2 Resource Definition

Resource URI: {apiRoot}/nudm-sdm/v1/{supi}/sdm-subscriptions/{subscriptionId}

This resource shall support the resource URI variables defined in table 6.1.3.4.2-1.

Table 6.1.3.4.2-1: Resource URI variables for this resource

Name	Definition
apiRoot	See subclause 6.1.1
supi	Represents the Subscription Permanent Identifier (see 3GPP TS 23.501 [2] clause 5.9.2) pattern: "(imsi-[0-9]{5,15} nai-.+ .+)")
subscriptionId	The subscriptionId identifies an individual subscription to notifications. The value is allocated by the UDM during creation of the Subscription resource.

6.1.3.4.3 Resource Standard Methods

6.1.3.4.3.1 DELETE

This method shall support the URI query parameters specified in table 6.1.3.4.3.1-1.

Table 6.1.3.4.3.1-1: URI query parameters supported by the DELETE method on this resource

Name	Data type	P	Cardinality	Description
n/a				

This method shall support the request data structures specified in table 6.1.3.4.3.1-2 and the response data structures and response codes specified in table 6.1.3.4.3.1-3.

Table 6.1.3.4.3.1-2: Data structures supported by the Delete Request Body on this resource

Data type	P	Cardinality	Description
n/a			The request body shall be empty.

Table 6.1.3.4.3.1-3: Data structures supported by the DELETE Response Body on this resource

Data type	P	Cardinality	Response codes	Description
n/a			204 No Content	Upon success, an empty response body shall be returned.
NOTE: In addition common data structures as listed in table 6.1.7-1 are supported.				

6.1.3.5 Resource: AccessAndMobilitySubscriptionData

6.1.3.5.1 Description

This resource represents the subscribed Access and Mobility Data for a SUPI. It is queried by the AMF after registering.

6.1.3.5.2 Resource Definition

Resource URI: {apiRoot}/nudm-sdm/v1/{supi}/am-data

This resource shall support the resource URI variables defined in table 6.1.3.5.2-1.

Table 6.1.3.5.2-1: Resource URI variables for this resource

Name	Definition
apiRoot	See subclause 6.1.1
supi	Represents the Subscription Permanent Identifier (see 3GPP TS 23.501 [2] clause 5.9.2) pattern: "(imsi-[0-9]{5,15} nai-.+ .+)")

6.1.3.5.3 Resource Standard Methods

6.1.3.5.3.1 GET

This method shall support the URI query parameters specified in table 6.1.3.5.3.1-1.

Table 6.1.3.5.3.1-1: URI query parameters supported by the GET method on this resource

Name	Data type	P	Cardinality	Description
supportedFeatures	SupportedFeatures	O	0..1	see 3GPP TS 29.500 [4] subclause 6.6
plmn-id	PlmnId	O	0..1	PLMN identity of the PLMN serving the UE

If "plmn-id" is included, UDM shall return the Access and Mobility Data for the SUPI associated to the PLMN identified by "plmn-id".

If "plmn-id" is not included, UDM shall return the Access and Mobility Data for the SUPI associated to the HPLMN.

This method shall support the request data structures specified in table 6.1.3.5.3.1-2 and the response data structures and response codes specified in table 6.1.3.5.3.1-3.

Table 6.1.3.5.3.1-2: Data structures supported by the GET Request Body on this resource

Data type	P	Cardinality	Description
n/a			

Table 6.1.3.5.3.1-3: Data structures supported by the GET Response Body on this resource

Data type	P	Cardinality	Response codes	Description
AccessAndMobilitySubscriptionData	M	1	200 OK	Upon success, a response body containing the Access and Mobility Subscription Data shall be returned.
NOTE: In addition common data structures as listed in table 6.1.7-1 are supported.				

6.1.3.6 Resource: SmfSelectionSubscriptionData

6.1.3.6.1 Description

This resource represents the subscribed SMF Selection Data for a SUPI. It is queried by the AMF after registering.

6.1.3.6.2 Resource Definition

Resource URI: {apiRoot}/nudm-sdm/v1/{supi}/smf-select-data

This resource shall support the resource URI variables defined in table 6.1.3.6.2-1.

Table 6.1.3.6.2-1: Resource URI variables for this resource

Name	Definition
apiRoot	See subclause 6.1.1
supi	Represents the Subscription Permanent Identifier (see 3GPP TS 23.501 [2] clause 5.9.2) pattern: "(imsi-[0-9]{5,15} nai-.+ .+)"

6.1.3.6.3 Resource Standard Methods

6.1.3.6.3.1 GET

This method shall support the URI query parameters specified in table 6.1.3.6.3.1-1.

Table 6.1.3.6.3.1-1: URI query parameters supported by the GET method on this resource

Name	Data type	P	Cardinality	Description
supportedFeatures	SupportedFeatures	O	0..1	see 3GPP TS 29.500 [4] subclause 6.6
plmn-id	PlmnId	O	0..1	PLMN identity of the PLMN serving the UE

If "plmn-id" is included, UDM shall return the SMF Selection Subscription Data for the SUPI associated to the PLMN identified by "plmn-id".

If "plmn-id" is not included, UDM shall return the SMF Selection Subscription Data for the SUPI associated to the HPLMN.

This method shall support the request data structures specified in table 6.1.3.6.3.1-2 and the response data structures and response codes specified in table 6.1.3.6.3.1-3.

Table 6.1.3.6.3.1-2: Data structures supported by the GET Request Body on this resource

Data type	P	Cardinality	Description
n/a			

Table 6.1.3.6.3.1-3: Data structures supported by the GET Response Body on this resource

Data type	P	Cardinality	Response codes	Description
SmfSelectionSubscriptionData	M	1	200 OK	Upon success, a response body containing the SMF Selection Subscription Data shall be returned.
NOTE: In addition common data structures as listed in table 6.1.7-1 are supported.				

6.1.3.7 Resource: UeContextInSmfData

6.1.3.7.1 Description

This resource represents the allocated SMFs for a SUPI. It is queried by the AMF after registering.

6.1.3.7.2 Resource Definition

Resource URI: {apiRoot}/nudm-sdm/v1/{supi}/ue-context-in-smf-data

This resource shall support the resource URI variables defined in table 6.1.3.7.2-1.

Table 6.1.3.7.2-1: Resource URI variables for this resource

Name	Definition
apiRoot	See subclause 6.1.1
supi	Represents the Subscription Permanent Identifier (see 3GPP TS 23.501 [2] clause 5.9.2) pattern: "(imsi-[0-9]{5,15} nai-.+ .+)")

6.1.3.7.3 Resource Standard Methods

6.1.3.7.3.1 GET

This method shall support the URI query parameters specified in table 6.1.3.7.3.1-1.

Table 6.1.3.7.3.1-1: URI query parameters supported by the GET method on this resource

Name	Data type	P	Cardinality	Description
supportedFeatures	SupportedFeatures	O	0..1	see 3GPP TS 29.500 [4] subclause 6.6

This method shall support the request data structures specified in table 6.1.3.7.3.1-2 and the response data structures and response codes specified in table 6.1.3.7.3.1-3.

Table 6.1.3.7.3.1-2: Data structures supported by the GET Request Body on this resource

Data type	P	Cardinality	Description
n/a			

Table 6.1.3.7.3.1-3: Data structures supported by the GET Response Body on this resource

Data type	P	Cardinality	Response codes	Description
UeContextInSmfData	M	1	200 OK	Upon success, a response body containing the UeContextInSmfData shall be returned.
NOTE: In addition common data structures as listed in table 6.1.7-1 are supported.				

6.1.3.8 Resource: SessionManagementSubscriptionData

6.1.3.8.1 Description

This resource represents the Session Management subscription data for a SUPI. It is queried by the SMF during session setup, using query parameters representing the selected network slice and the DNN. The SMF is responsible for enforcing the user session management subscription data.

6.1.3.8.2 Resource Definition

Resource URI: {apiRoot}/nudm-sdm/v1/{supi}/sm-data

This resource shall support the resource URI variables defined in table 6.1.3.8.2-1.

Table 6.1.3.8.2-1: Resource URI variables for this resource

Name	Definition
apiRoot	See subclause 6.1.1
supi	Represents the Subscription Permanent Identifier (see 3GPP TS 23.501 [2] clause 5.9.2) pattern: "(imsi-[0-9]{5,15} nai-.+ .+)")

6.1.3.8.3 Resource Standard Methods

6.1.3.8.3.1 GET

This method shall support the URI query parameters specified in table 6.1.3.8.3.1-1.

Table 6.1.3.8.3.1-1: URI query parameters supported by the GET method on this resource

Name	Data type	P	Cardinality	Description
supportedFeatures	SupportedFeatures	O	0..1	see 3GPP TS 29.500 [4] subclause 6.6
singleNssai	Snsai	O	0..1	
dnn	Dnn	O	0..1	
plmn-id	PlmnId	O	0..1	PLMN identity of the PLMN serving the UE

JSON objects (such as Snsai, PlmnId...) shall be included directly as part of the URI query parameters by specifying in the OpenAPI file that the "Content-Type" of such parameters is "application/json".

If "singleNssai" is not included, and "dnn" is not included, UDM shall return all DNN configurations for all network slice(s).

If "singleNssai" is included, and "dnn" is not included, UDM shall return all DNN configurations for the requested network slice identified by "singleNssai".

If "singleNssai" is not included, and "dnn" is included, UDM shall return all DNN configurations identified by "dnn" for all network slices where such DNN is available.

If "singleNssai" is included, and "dnn" is included, UDM shall return the DNN configuration identified by "dnn", if such DNN is available in the network slice identified by "singleNssai".

For all the combinations about the inclusion of "dnn" and "singleNssai" as URI query parameters, if "plmn-id" is included, UDM shall return the configurations for the DNN and network slices associated to the PLMN identified by "plmn-id". Otherwise (i.e. if "plmn-id" is not included), UDM shall return the configurations for the DNN and network slices associated to the HPLMN.

This method shall support the request data structures specified in table 6.1.3.8.3.1-2 and the response data structures and response codes specified in table 6.1.3.8.3.1-3.

Table 6.1.3.8.3.1-2: Data structures supported by the GET Request Body on this resource

Data type	P	Cardinality	Description
n/a			

Table 6.1.3.8.3.1-3: Data structures supported by the GET Response Body on this resource

Data type	P	Cardinality	Response codes	Description
array(SessionManagementSubscriptionData)	M	1..N	200 OK	Upon success, a response body containing the Session Management Subscription data shall be returned.
NOTE: In addition common data structures as listed in table 6.1.7-1 are supported.				

6.1.3.9 Resource: SMSSubscriptionData

6.1.3.9.1 Description

This resource represents the subscribed SMS Subscription Data for a SUPI. It is queried by the AMF after registering.

6.1.3.9.2 Resource Definition

Resource URI: {apiRoot}/nudm-sdm/v1/{supi}/sms-data

This resource shall support the resource URI variables defined in table 6.1.3.9.2-1.

Table 6.1.3.9.2-1: Resource URI variables for this resource

Name	Definition
apiRoot	See subclause 6.1.1
supi	Represents the Subscription Permanent Identifier (see 3GPP TS 23.501 [2] clause 5.9.2) pattern: "(imsi-[0-9]{5,15}nai-.+ .+)"

6.1.3.9.3 Resource Standard Methods

6.1.3.9.3.1 GET

This method shall support the URI query parameters specified in table 6.1.3.9.3.1-1.

Table 6.1.3.9.3.1-1: URI query parameters supported by the GET method on this resource

Name	Data type	P	Cardinality	Description
plmn-id	PlmnId	C	0..1	if absent, H-PLMN ID is used as default
supportedFeatures	SupportedFeatures	O	0..1	see 3GPP TS 29.500 [4] subclause 6.6

This method shall support the request data structures specified in table 6.1.3.9.3.1-2 and the response data structures and response codes specified in table 6.1.3.9.3.1-3.

Table 6.1.3.9.3.1-2: Data structures supported by the GET Request Body on this resource

Data type	P	Cardinality	Description
n/a			

Table 6.1.3.9.3.1-3: Data structures supported by the GET Response Body on this resource

Data type	P	Cardinality	Response codes	Description
SmsSubscriptionData	M	1	200 OK	Upon success, a response body containing the SMS Subscription Data shall be returned.
NOTE: In addition common data structures as listed in table 6.1.7-1 are supported.				

6.1.3.10 Resource: SMSManagementSubscriptionData

6.1.3.10.1 Description

This resource represents the subscribed SMS Management Data for a SUPI. It is queried by the SMSF after registering.

6.1.3.10.2 Resource Definition

Resource URI: {apiRoot}/nudm-sdm/v1/{supi}/sms-mng-data

This resource shall support the resource URI variables defined in table 6.1.3.10.2-1.

Table 6.1.3.10.2-1: Resource URI variables for this resource

Name	Definition
apiRoot	See subclause 6.1.1
supi	Represents the Subscription Permanent Identifier (see 3GPP TS 23.501 [2] clause 5.9.2) pattern: "(imsi-[0-9]{5,15} nai-.+ .+)")

6.1.3.10.3 Resource Standard Methods

6.1.3.10.3.1 GET

This method shall support the URI query parameters specified in table 6.1.3.10.3.1-1.

Table 6.1.3.10.3.1-1: URI query parameters supported by the GET method on this resource

Name	Data type	P	Cardinality	Description
plmn-id	PlmnId	C	0..1	if absent, H-PLMN ID is used as default
supportedFeatures	SupportedFeatures	O	0..1	see 3GPP TS 29.500 [4] subclause 6.6

This method shall support the request data structures specified in table 6.1.3.10.3.1-2 and the response data structures and response codes specified in table 6.1.3.10.3.1-3.

Table 6.1.3.10.3.1-2: Data structures supported by the GET Request Body on this resource

Data type	P	Cardinality	Description
n/a			

Table 6.1.3.10.3.1-3: Data structures supported by the GET Response Body on this resource

Data type	P	Cardinality	Response codes	Description
SmsManagementSubscriptionData	M	1	200 OK	Upon success, a response body containing the SMS Management Subscription Data shall be returned.
NOTE: In addition common data structures as listed in table 6.1.7-1 are supported.				

6.1.3.11 Resource: Supi

6.1.3.11.1 Description

This resource represents the subscription profile of the subscriber identified by a given SUPI.

6.1.3.11.2 Resource Definition

Resource URI: {apiRoot}/nudm-sdm/v1/{supi}

This resource shall support the resource URI variables defined in table 6.1.3.11.2-1.

Table 6.1.3.11.2-1: Resource URI variables for this resource

Name	Definition
apiRoot	See subclause 6.1.1
supi	Represents the Subscription Permanent Identifier (see 3GPP TS 23.501 [2] clause 5.9.2) pattern: "(imsi-[0-9]{5,15} nai-.+)"

6.1.3.11.3 Resource Standard Methods

6.1.3.11.3.1 GET

This method shall support the URI query parameters specified in table 6.1.3.11.3.1-1.

NOTE: The retrieval of these data sets can also be achieved by sending individual GET requests to the corresponding sub-resources under the {supi} resource. When multiple data sets need to be retrieved by the NF Service consumer, it is recommended to use a single GET request with query parameters rather than issuing multiple GET requests.

Table 6.1.3.11.3.1-1: URI query parameters supported by the GET method on this resource

Name	Data type	P	Cardinality	Description
dataset-name	array(DataSetName)	M	1..N	
plmn-id	PlmnId	C	0..1	if absent, H-PLMN ID is used as default
supportedFeatures	SupportedFeatures	O	0..1	see 3GPP TS 29.500 [4] subclause 6.6

This method shall support the request data structures specified in table 6.1.3.11.3.1-2 and the response data structures and response codes specified in table 6.1.3.11.3.1-3.

Table 6.1.3.11.3.1-2: Data structures supported by the GET Request Body on this resource

Data type	P	Cardinality	Description
n/a			

Table 6.1.3.11.3.1-3: Data structures supported by the GET Response Body on this resource

Data type	P	Cardinality	Response codes	Description
SubscriptionDataSets	M	1	200 OK	Upon success, a response body containing the requested data sets shall be returned.

NOTE: In addition common data structures as listed in table 6.1.7-1 are supported.

6.1.3.12 Resource: IdTranslationResult

6.1.3.12.1 Description

This resource represents the SUPI. It is queried by the NEF for GPSI to SUPI translation. See 3GPP TS 23.502 [3] clause 4.13.2.2.

6.1.3.12.2 Resource Definition

Resource URI: {apiRoot}/nudm-sdm/v1/{gpsi}/id-translation-result

This resource shall support the resource URI variables defined in table 6.1.3.12.2-1.

Table 6.1.3.12.2-1: Resource URI variables for this resource

Name	Definition
apiRoot	See subclause 6.1.1
gpsi	Represents the Generic Public Subscription Identifier (see 3GPP TS 23.501 [2] subclause 5.9.8) pattern: "(msisdn-[0-9]{5,15} ext-id-.[@.+.+)")"

6.1.3.12.3 Resource Standard Methods

6.1.3.12.3.1 GET

This method shall support the URI query parameters specified in table 6.1.3.12.3.1-1.

Table 6.1.3.12.3.1-1: URI query parameters supported by the GET method on this resource

Name	Data type	P	Cardinality	Description
supportedFeatures	SupportedFeatures	O	0..1	see 3GPP TS 29.500 [4] subclause 6.6

This method shall support the request data structures specified in table 6.1.3.12.3.1-2 and the response data structures and response codes specified in table 6.1.3.12.3.1-3.

Table 6.1.3.12.3.1-2: Data structures supported by the GET Request Body on this resource

Data type	P	Cardinality	Description
n/a			

Table 6.1.3.12.3.1-3: Data structures supported by the GET Response Body on this resource

Data type	P	Cardinality	Response codes	Description
IdTranslationResult	M	1	200 OK	Upon success, a response body containing the SUPI and optionally the MSISDN shall be returned.
NOTE: In addition common data structures as listed in table 6.1.7-1 are supported.				

6.1.4 Custom Operations without associated resources

In this release of this specification, no custom operations without associated resources are defined for the Nudm_SubscriberDataManagement Service.

6.1.5 Notifications

6.1.5.1 General

This subclause will specify the use of notifications and corresponding protocol details if required for the specific service. When notifications are supported by the API, it will include a reference to the general description of notifications support over the 5G SBIs specified in TS 29.500 / TS 29.501.

6.1.5.2 Data Change Notification

The POST method shall be used for Data Change Notifications and the URI shall be as provided during the subscription procedure.

Resource URI: {callbackReference}

Support of URI query parameters is specified in table 6.1.5.2-1.

Table 6.1.5.2-1: URI query parameters supported by the POST method

Name	Data type	P	Cardinality	Description
n/a				

Support of request data structures is specified in table 6.1.5.2-2 and of response data structures and response codes is specified in table 6.1.5.2-3.

Table 6.1.5.2-2: Data structures supported by the POST Request Body

Data type	P	Cardinality	Description
ModificationNotification	M	1	

Table 6.1.5.2-3: Data structures supported by the POST Response Body

Data type	P	Cardinality	Response codes	Description
n/a			204 No Content	Upon success, an empty response body shall be returned.
NOTE: In addition common data structures as listed in table 6.1.7-1 are supported.				

6.1.6 Data Model

6.1.6.1 General

This subclause specifies the application data model supported by the API.

Table 6.1.6.1-1 specifies the structured data types defined for the Nudm_SDM service API. For simple data types defined for the Nudm_SDM service API see table 6.1.6.3.2-1.

Table 6.1.6.1-1: Nudm_SDM specific Data Types

Data type	Section defined	Description
Nssai	6.1.6.2.2	Network Slice Selection Assistance Information
SdmSubscription	6.1.6.2.3	A subscription to notifications
AccessAndMobilitySubscriptionData	6.1.6.2.4	Access and Mobility Subscription Data
SmfSelectionSubscriptionData	6.1.6.2.5	SMF Selection Subscription Data
UeContextInSmfData	6.1.6.2.16	UE Context In SMF Data
PduSession	6.1.6.2.17	
DnnInfo	6.1.6.2.6	Data Network Name and associated information (LBO roaming allowed flag)
SnsaiInfo	6.1.6.2.7	S-NSSAI and associated information (DNN Info)
SessionManagementSubscriptionData	6.1.6.2.8	User subscribed session management data
DnnConfiguration	6.1.6.2.9	User subscribed data network configuration
5GQosProfile	6.1.6.2.10	5G QoS parameters associated to the session for a data network
PduSessionTypes	6.1.6.2.11	Default/allowed session types for a data network
SscModes	6.1.6.2.12	Default/allowed SSC modes for a data network
SmsManagementSubscriptionData	6.1.6.2.14	SMS Management Subscription Data
IdTranslationResult	6.1.6.2.18	SUPI that corresponds to a given GPSI
AreaRestriction	6.1.6.2.19	Subscribed Service Area Restrictions and Forbidden Areas
AreaInformation	6.1.6.2.20	Restriction Area Information
IpAddress	6.1.6.2.22	IP address (IPv4, or IPv6, or IPv6 prefix)
3GppChargingCharacteristics	6.1.6.3.2	3GPP Charging Characteristics
CoreNetworkType	6.1.6.3.6	Enumeration of the different Core Network types (5GC, EPC...)
ModificationNotification	6.1.6.2.21	

Table 6.1.6.1-2 specifies data types re-used by the Nudm_SDM service API from other specifications, including a reference to their respective specifications and when needed, a short description of their use within the Nudm_SDM service API.

Table 6.1.6.1-2: Nudm_SDM re-used Data Types

Data type	Reference	Comments
Dnn	3GPP TS 29.571 [7]	Data Network Name
DurationSec	3GPP TS 29.571 [7]	Time value in seconds
ProblemDetails	3GPP TS 29.571 [7]	Common data type used in response bodies
Snsai	3GPP TS 29.571 [7]	Single NSSAI
Uri	3GPP TS 29.571 [7]	Uniform Resource Identifier
Gpsi	3GPP TS 29.571 [7]	Generic Public Subscription Identifier
RatType	3GPP TS 29.571 [7]	Radio Access Technology Type
SupportedFeatures	3GPP TS 29.571 [7]	see 3GPP TS 29.500 [4] subclause 6.6
PlmnId	3GPP TS 29.571 [7]	PLMN Identity
PduSessionType	3GPP TS 29.571 [7]	
5qi	3GPP TS 29.571 [7]	
Arp	3GPP TS 29.571 [7]	
Ambr	3GPP TS 29.571 [7]	
PduSessionId	3GPP TS 29.571 [7]	
NfInstanceId	3GPP TS 29.571 [7]	
Supi	3GPP TS 29.571 [7]	
RfspIndex	3GPP TS 29.571 [7]	
SscMode	3GPP TS 29.571 [7]	
Ipv4Address	3GPP TS 29.571 [7]	
Ipv6Address	3GPP TS 29.571 [7]	
Ipv6Prefix	3GPP TS 29.571 [7]	

6.1.6.2 Structured data types

6.1.6.2.1 Introduction

This subclause defines the structures to be used in resource representations.

Allowed structures are: array, object.

6.1.6.2.2 Type: Nssai

Table 6.1.6.2.2-1: Definition of type Nssai

Attribute name	Data type	P	Cardinality	Description
supportedFeatures	SupportedFeatures	O	0..1	See subclause 6.1.8
defaultSingleNssais	array(Snssai)	O	0..8	A list of Single Nssai used as default
singleNssais	array(Snssai)	O	0..N	A list of Single Nssai

6.1.6.2.3 Type: SdmSubscription

Table 6.1.6.2.3-1: SdmSubscription

Attribute name	Data type	P	Cardinality	Description
callbackReference	Uri	M	1	URI provided by the NF service consumer to receive notifications
monitoredResourceUris	array(Uri)	M	1..N	A set of URIs that identify the resources for which a change triggers a notification

6.1.6.2.4 Type: AccessAndMobilitySubscriptionData

Table 6.1.6.2.4-1: Definition of type AccessAndMobilitySubscriptionData

Attribute name	Data type	P	Cardinality	Description
supportedFeatures	SupportedFeatures	O	0..1	See subclause 6.1.8
gpsis	array(Gpsi)	O	0..N	List of Generic Public Subscription Identifier; see 3GPP TS 29.571 [7]
internalGroupIds	array(InternalGroupId)	O	0..N	List of internal group identifier; see 3GPP TS 23.501 [2] subclause 5.9.7
subscribed-UeAmbr	Ambr	O	0..1	
nssai	Nssai	O	0..1	Network Slice Selection Assistance Information
ratRestrictions	array(RatType)	O	0..N	List of RAT Types that are restricted; see 3GPP TS 29.571 [7]
areaRestrictions	array(AreaRestriction)	O	0..N	Subscribed Service Area Restrictions and Forbidden Areas
coreNetworkTypeRestrictions	array(CoreNetworkType)	O	0..N	List of Core Network Types that are restricted
rfspIndex	RfspIndex	O	0..1	Index to RAT/Frequency Selection Priority;
subsRegTimer	DurationSec	O	0..1	Subscribed periodic registration timer; see 3GPP TS 29.571 [7]
ueUsageType	UeUsageType	O	0..1	
ladnInformation	array(Dnn)	O	0..N	Subscribed DNNs with LADN indicator set
mpsPriority	MpsPriorityIndicator	O	0..1	
activeTime	DurationSec	O	0..1	subscribed active time for PSM UEs
dIPacketCount	DIPacketCount	O	0..1	DL Buffering Suggested Packet Count indicates whether extended buffering of downlink packets for High Latency Communication is requested.

6.1.6.2.5 Type: SmfSelectionSubscriptionData

Table 6.1.6.2.5-1: Definition of type SmfSelectionSubscriptionData

Attribute name	Data type	P	Cardinality	Description
supportedFeatures	SupportedFeatures	O	0..1	See subclause 6.1.8
subscribedSnssaiInfo	array(SnssaiInfo)	O	0..N	List of S-NSSAIs and associated information (DNN Info); see 3GPP TS 23.501 [2] clause 6.3.2.

6.1.6.2.6 Type: DnnInfo

Table 6.1.6.2.6-1: Definition of type DnnInfo

Attribute name	Data type	P	Cardinality	Description
dnn	Dnn	M	1	Data Network Name
defaultDnnIndicator	DefaultDnnIndicator	O	0..1	Indicates whether this DNN is the default DNN: true: The DNN is the default DNN; false: The DNN is not the default DNN; absent: The DNN is not the default DNN
lboRoamingAllowed	LboRoamingAllowed	O	0..1	indicates whether local breakout for the DNN is allowed when roaming: true: Allowed; false: Not allowed; absent: Not allowed;

6.1.6.2.7 Type: SnssaiInfo

Table 6.1.6.2.7-1: Definition of type SnssaiInfo

Attribute name	Data type	P	Cardinality	Description
singleNssai	Snssai	M	1	SingleNssai
dnnInfos	array(DnnInfo)	M	1..N	list of Data Network Names for the S-NSSAI and associated information

6.1.6.2.8 Type: SessionManagementSubscriptionData

Table 6.1.6.2.8-1: SessionManagementSubscriptionData

Attribute name	Data type	P	Cardinality	Description
singleNssai	Snssai	M	1	A single Network Slice Selection Assistance Information
dnnConfiguration	map(DnnConfiguration)	O	0..N	Additional DNNs configuration for the network slice; A map (list of key-value pairs where dnn serves as key) of DnnConfigurations.

6.1.6.2.9 Type: DnnConfiguration

Table 6.1.6.2.9-1: DnnConfiguration

Attribute name	Data type	P	Cardinality	Description
dnn	Dnn	M	1	Data Network Name
pduSessionTypes	PduSessionTypes	M	1	Default/Allowed session types
sscModes	SscModes	M	1	Default/Allowed SSC modes
ladnIndicator	LadnIndicator	O	0..1	Indicates whether the DNN is a local area data network
5gQosProfile	5GQosProfile	O	0..1	5G QoS parameters associated to the session for a data network
sessionAMBR	Ambr	O	0..1	The maximum aggregated uplink and downlink bit rates to be shared across all Non-GBR QoS Flows in each PDU Session
3gppChargingCharacteristics	3GppChargingCharacteristics	O	0..1	Subscribed charging characteristics data associated to the session for a data network
staticIpAddress	IpAddress	O	0..2	Subscribed static IP address(es) of the IPv4 and/or IPv6 type

6.1.6.2.10 Type: 5GQosProfile

Table 6.1.6.2.10-1: 5GQosProfile

Attribute name	Data type	P	Cardinality	Description
5qi	5qi	M	1	Default 5G QoS identifier
arp	Arp	O	0..1	Default allocation and retention priority

6.1.6.2.11 Type: PduSessionTypes

Table 6.1.6.2.11-1: PduSessionTypes

Attribute name	Data type	P	Cardinality	Description
defaultSessionType	PduSessionType	M	1	Default session type
allowedSessionTypes	array(PduSessionType)	O	0..N	Additional session types allowed for the data network

6.1.6.2.12 Type: SscModes

Table 6.1.6.2.12-1: SscModes

Attribute name	Data type	P	Cardinality	Description
defaultSscMode	SscMode	M	1	Default SSC mode
allowedSscModes	array(SscMode)	O	0..2	Additional SSC modes allowed for the data network

6.1.6.2.13 Type: SmsSubscriptionData

Table 6.1.6.2.13-1: Definition of type SmsSubscriptionData

Attribute name	Data type	P	Cardinality	Description
smsSupported	SmsSupport	O	0..1	Indicates whether the UE supports SMS delivery over NAS via 3GPP access, or via non-3GPP access, or via both the 3GPP and non-3GPP access.
smsf3GppAddress (FFS)	FFS	C	0..1	Indicates SMSF address registered for SMS service via 3GPP access.
smsfNon3GppAddress (FFS)	FFS	C	0..1	Indicates SMSF address registered for SMS service via non-3GPP access.

Editor's Note: It should be clarified how the UDM receives these data attributes, and what's their intended usage by UDM.

6.1.6.2.14 Type: SmsManagementSubscriptionData

Table 6.1.6.2.14-1: Definition of type SmsManagementSubscriptionData

Attribute name	Data type	P	Cardinality	Description
supportedFeatures	SupportedFeatures	O	0..1	See subclause 6.1.8
mtSmsSubscribed	boolean	M	1	Indicates the SMS teleservice subscription for MT-SMS
mtSmsBarringAll	boolean	C	0..1	Barring of all incoming calls for MT-SMS
mtSmsBarringRoaming	boolean	C	0..1	Barring of incoming calls for MT-SMS when roaming outside the Home Public Land Mobile Network (PLMN) country
moSmsSubscribed	boolean	M	1	Indicates the SMS teleservice subscription for MO-SMS
moSmsBarringAll	boolean	C	0..1	Barring of all outgoing calls for MO-SMS
moSmsbarringRoaming	boolean	C	0..1	Barring of outgoing calls for MO-SMS when roaming outside the Home Public Land Mobile Network (PLMN) country

6.1.6.2.15 Type: SubscriptionDataSets

Table 6.1.6.2.15-1: SubscriptionDataSets

Attribute name	Data type	P	Cardinality	Description
amData	AccessAndMobilitySubscriptionData	O	0..1	Access and Mobility Subscription Data
smfSelData	SmfSelectionSubscriptionData	O	0..1	SMF Selection Subscription Data

6.1.6.2.16 Type: UeContextInSmfData

Table 6.1.6.2.16-1: Definition of type UeContextInSmfData

Attribute name	Data type	P	Cardinality	Description
pduSessions	map(PduSession)	M	1..N	A map (list of key-value pairs where pduSessionId converted from integer to string serves as key) of PduSessions.

6.1.6.2.17 Type: PduSession

Table 6.1.6.2.17-1: Definition of type PduSession

Attribute name	Data type	P	Cardinality	Description
pduSessionId	PduSessionId	M	1	Identifier of the PDU Session
dnn	Dnn	M	1	Data Network Name
smfId	NfInstanceId	M	1	Nf-Id of the SMF
smfAddress	IpAddress	M	1	IP address of the SMF

6.1.6.2.18 Type: IdTranslationResult

Table 6.1.6.2.18-1: Definition of type IdTranslationResult

Attribute name	Data type	P	Cardinality	Description
supportedFeatures	SupportedFeatures	O	0..1	See subclause 6.1.8
supi	Supi	M	1	SUPI
gpsi	Gpsi	O	0..1	shall be an MSISDN

6.1.6.2.19 Type: AreaRestriction

Table 6.1.6.2.19-1: AreaRestriction

Attribute name	Data type	P	Cardinality	Description
restrictionType	RestrictionType	M	1	Type of restriction
areaInformation	AreaInformation	O	0..1	Restriction Area Information
ratTypes	array(RatType)	O	0..N	Applicable RATs (in case this IE is absent, the restrictions apply to all RATs)

Editor's Note: The final decision on the exact modelling of mobility restrictions is pending clarifications from stage-2; this applies to the structures "AreaRestriction", "AreaInformation" and "RestrictionType" data types.

6.1.6.2.20 Type: AreaInformation

Table 6.1.6.2.20-1: AreaInformation

Attribute name	Data type	P	Cardinality	Description
tacs	array(Tac)	O	0..N	Tracking Area Code
areaCodes	array(string)	O	0..N	Each area code represents a collection of tracking areas. The determination of the areas is defined in the serving node.
maxNumberTAs	integer	O	0..1	Maximum number of allowed Tracking Areas.

6.1.6.2.21 Type: ModificationNotification

Table 6.1.6.2.21-1: ModificationNotification

Attribute name	Data type	P	Cardinality	Description
amDataModification	AccessAndMobilitySubscriptionData	O	0..1	
smfSelDataModification	SmfSelectionSubscriptionData	O	0..1	
smsMngDataModification	SmsManagementSubscriptionData	O	0..1	
smDataModification	SessionManagementSubscriptionData	O	0..1	

6.1.6.2.22 Type: IpAddress

Table 6.1.6.2.22-1: IpAddress

Attribute name	Data type	P	Cardinality	Description
ipv4Addr	Ipv4Addr	C	0..1	
ipv6Addr	Ipv6Addr	C	0..1	
ipv6Prefix	Ipv6Prefix	C	0..1	
NOTE: Either ipv4Addr, or ipv6Addr, or ipv6Prefix shall be present.				

6.1.6.3 Simple data types and enumerations

6.1.6.3.1 Introduction

This subclause defines simple data types and enumerations that can be referenced from data structures defined in the previous subclauses.

6.1.6.3.2 Simple data types

The simple data types defined in table 6.1.6.3.2-1 shall be supported.

Table 6.1.6.3.2-1: Simple data types

Type Name	Type Definition	Description
DefaultDnnIndicator	boolean	Indicates whether a DNN is the default DNN
LadnIndicator	boolean	Indicates whether the DNN is a local area data network
LboRoamingAllowed	boolean	This flag indicates whether local breakout is allowed when roaming.
UeUsageType	integer	Indicates the usage characteristics of the UE, enables the selection of a specific Dedicated Core Network for EPS interworking
MpsPriorityIndicator	boolean	Indicates whether UE is subscribed to multimedia priority service
3GppChargingCharacteristics	string	16-bit string identifying charging characteristics as specified in 3GPP TS 32.251 [11] Annex A and 3GPP TS 32.298 [12] section 5.1.2.2.7, in hexadecimal representation. Each character in the string shall take a value of "0" to "9" or "A" to "F" and shall represent 4 bits. The most significant character representing the 4 most significant bits of the charging characteristics shall appear first in the string, and the character representing the 4 least significant bits of the charging characteristics shall appear last in the string. Example: The charging characteristic 0x123A shall be encoded as "123A".
DIPacketCount	integer	The following values are defined: 0: "Extended DL Data Buffering NOT REQUESTED" -1: "Extended DL Data Buffering REQUESTED, without a suggested number of packets" n>0: "Extended DL Data Buffering REQUESTED, with a suggested number of n packets"
InternalGroupIid	string	see 3GPP TS 23.501 [2] subclause 5.9.7

6.1.6.3.3 Enumeration: DataSetName

Table 6.1.6.3.3-1: Enumeration DataSetName

Enumeration value	Description
"AM"	Access and Mobility Subscription Data
"SMF_SEL"	SMF Selection Subscription Data

Editor's Note: The current naming conventions for Enumerations (uppercase with underscore), when their intended usage is for query parameters is not consistent with the naming conventions for URI components (lowercase with hyphen).

6.1.6.3.4 Enumeration: SmsSupport

Table 6.1.6.3.4-1: Enumeration SmsSupport

Enumeration value	Description
"SMS_3GPP"	UE supports SMS delivery over NAS via 3GPP access
"SMS_NON_3GPP"	UE supports SMS delivery over NAS via non-3GPP access
"SMS_3GPP_AND_NON_3GPP"	UE supports SMS delivery over NAS via both the 3GPP and non-3GPP access

6.1.6.3.5 Enumeration: RestrictionType

Table 6.1.6.3.5-1: Enumeration RestrictionType

Enumeration value	Description
"SAR_ALLOWED_AREA"	Service Area Restriction - Allowed area
"SAR_NOT_ALLOWED_AREA"	Service Area Restriction - Not allowed area
"FORBIDDEN_AREA"	Forbidden area

6.1.6.3.6 Enumeration: CoreNetworkType

Table 6.1.6.3.6-1: Enumeration CoreNetworkType

Enumeration value	Description
"5GC"	5G Core
"EPC"	Evolved Packet Core

6.1.7 Error Handling

Table 6.1.7-1 lists common response body data structures used within the nudm_sdm API.

Table 6.1.7-1: Common Response Body Data Structures

Data type	P	Cardinality	Response codes	Description
NOTE: In addition common data structures as defined in 3GPP TS 29.500 [4] are supported.				

6.1.8 Feature Negotiation

The optional features in table 6.1.8-1 are defined for the Nudm_SDM API. They shall be negotiated using the extensibility mechanism defined in subclause 6.6 of 3GPP TS 29.500 [4].

Table 6.1.8-1: Supported Features

Feature number	Feature Name	Description

Editor's Note: The concept of supportedFeatures as query parameter in GET requests needs to be confirmed and described in TS 29.500.

6.1.9 Security

As indicated in 3GPP TS 33.501 [6], the access to the Nudm_SDM API shall be authorized by means of the OAuth2 protocol (see IETF RFC 6749 [18]), using the "Client Credentials" authorization grant, where the NRF (see 3GPP TS 29.510 [19]) plays the role of the authorization server.

An NF Service Consumer, prior to consuming services offered by the Nudm_SDM API, shall obtain a "token" from the authorization server, by invoking the Access Token Request service, as described in 3GPP TS 29.510 [19], subclause 5.4.2.2.

NOTE: When multiple NRFs are deployed in a network, the NRF used as authorization server is the same NRF that the NF Service Consumer used for discovering the Nudm_SDM service.

The Nudm_SDM API does not define any scopes for OAuth2 authorization.

6.2 Nudm_UEContextManagement Service API

6.2.1 API URI

URIs of this API shall have the following root:

```
{apiRoot}/{apiName}/{apiVersion}/
```

where the "apiName" shall be set to "nudm-uecm" and the "apiVersion" shall be set to "v1" for the current version of this specification.

6.2.2 Usage of HTTP

6.2.2.1 General

HTTP/2, as defined in IETF RFC 7540 [13], shall be used as specified in clause 5 of 3GPP TS 29.500 [4].

HTTP/2 shall be transported as specified in subclause 5.3 of 3GPP TS 29.500 [4].

HTTP messages and bodies for the Nudm_UECM service shall comply with the OpenAPI [14] specification contained in Annex A3.

6.2.2.2 HTTP standard headers

6.2.2.2.1 General

The usage of HTTP standard headers shall be supported as specified in subclause 5.2.2 of 3GPP TS 29.500 [4].

6.2.2.2.2 Content type

The following content types shall be supported:

JSON, as defined in IETF RFC 8259 [15], signalled by the content type "application/json".

The Problem Details JSON Object (IETF RFC 7807 [16]) signalled by the content type "application/problem+json"

JSON Merge Patch, as defined in IETF RFC 7396 [17], signalled by the content type "application/merge-patch+json"

6.2.2.3 HTTP custom headers

6.2.2.3.1 General

The usage of HTTP custom headers shall be supported as specified in subclause 5.2.3 of 3GPP TS 29.500 [4].

6.2.3 Resources

6.2.3.1 Overview

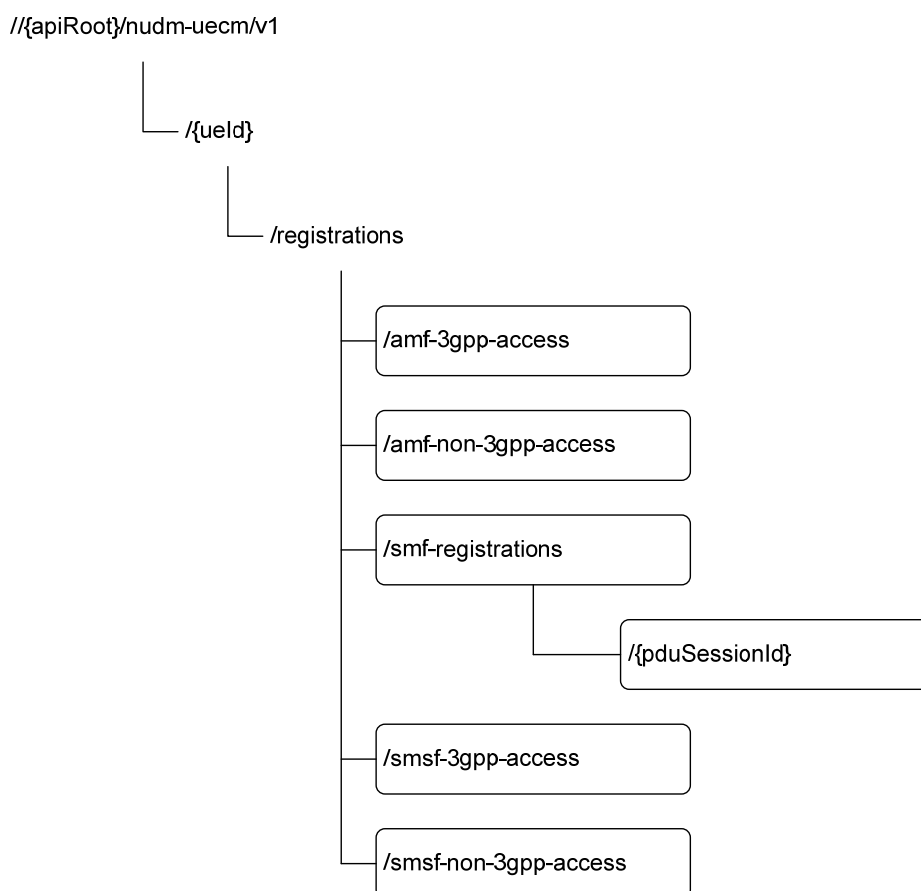

Figure 6.2.3.1-1: Resource URI structure of the Nudm_UECM API

Table 6.2.3.1-1 provides an overview of the resources and applicable HTTP methods.

Table 6.2.3.1-1: Resources and methods overview

Resource name (Archetype)	Resource URI	HTTP method or custom operation	Description
Amf3GppAccessRegistration (Document)	//{ueId}/registrations/amf-3gpp-access	PUT	Update the AMF registration for 3GPP access
		PATCH	Modify the AMF registration for 3GPP access
		GET	Retrieve the AMF registration information for 3GPP access
AmfNon3GppAccessRegistration (Document)	//{ueId}/registrations/amf-non-3gpp-access	PUT	Update the AMF registration for non 3GPP access
		PATCH	Modify the AMF registration for non 3GPP access
		GET	Retrieve the AMF registration information for non 3GPP access
SmfRegistrations (Store)	//{ueId}/registrations/smf-registrations		
IndividualSmfRegistration (Document)	//{ueId}/registrations/smf-registrations/{pduSessionId}	PUT	Create an SMF registration identified by PDU Session Id
		DELETE	Delete an individual SMF registration
		PATCH	Modify an individual SMF Registration
Smsf3GppAccessRegistration (Document)	//{ueId}/registrations/smsf-3gpp-access	PUT	Create or Update the SMSF registration
		DELETE	Delete the SMSF registration for 3GPP access
		PATCH	Modify the SMSF registration
		GET	Retrieve the SMSF registration information
SmsfNon3GppAccessRegistration (Document)	//{ueId}/registrations/smsf-non-3gpp-access	PUT	Create or Update the SMSF registration for non 3GPP access
		DELETE	Delete the SMSF registration for non 3GPP access
		PATCH	Modify the SMSF registration for non 3GPP access
		GET	Retrieve the SMSF registration information for non 3GPP access

6.2.3.2 Resource: Amf3GppAccessRegistration

6.2.3.2.1 Description

This resource represents the registered AMF for 3GPP access.

6.2.3.2.2 Resource Definition

Resource URI: {apiRoot}/nudm-uecm/v1/{ueId}/registrations/amf-3gpp-access

This resource shall support the resource URI variables defined in table 6.2.3.2.2-1.

Table 6.2.3.2.2-1: Resource URI variables for this resource

Name	Definition
apiRoot	See subclause 6.2.1
ueld	Represents the Subscription Identifier SUPI or GPSI (see 3GPP TS 23.501 [2] clause 5.9.2) SUPI (i.e. imsi or nai) is used with the PUT and PATCH methods; GPSI (i.e. msisdn or extid) is used with the GET method. pattern: "(imsi-[0-9]{5,15} nai-.+ msisdn-[0-9]{5,15} extid-.+ .+)"

6.2.3.2.3 Resource Standard Methods

6.2.3.2.3.1 PUT

This method shall support the URI query parameters specified in table 6.2.3.2.3.1-1.

Table 6.2.3.2.3.1-1: URI query parameters supported by the PUT method on this resource

Name	Data type	P	Cardinality	Description
n/a				

This method shall support the request data structures specified in table 6.2.3.2.3.1-2 and the response data structures and response codes specified in table 6.2.3.2.3.1-3.

Table 6.2.3.2.3.1-2: Data structures supported by the PUT Request Body on this resource

Data type	P	Cardinality	Description
Amf3GppAccessRegistration	M	1	The AMF registration for 3GPP access is replaced with the received information.

Table 6.2.3.2.3.1-3: Data structures supported by the PUT Response Body on this resource

Data type	P	Cardinality	Response codes	Description
n/a			204 No Content	Upon success, an empty response body shall be returned
NOTE: In addition common data structures as listed in table 6.2.7-1 are supported.				

6.2.3.2.3.2 PATCH

This method shall support the URI query parameters specified in table 6.2.3.2.3.2-1.

Table 6.2.3.2.3.2-1: URI query parameters supported by the PATCH method on this resource

Name	Data type	P	Cardinality	Description
n/a				

This method shall support the request data structures specified in table 6.2.3.2.3.2-2 and the response data structures and response codes specified in table 6.2.3.2.3.2-3.

Table 6.2.3.2.3.2-2: Data structures supported by the PATCH Request Body on this resource

Data type	P	Cardinality	Description
Amf3GppAccessRegistrationModification	M	1	The AMF registration for 3GPP access is modified with the received information.

Table 6.2.3.2.3.2-3: Data structures supported by the PATCH Response Body on this resource

Data type	P	Cardinality	Response codes	Description
n/a			204 No Content	Upon success, an empty response body shall be returned
NOTE: In addition common data structures as listed in table 6.2.7-1 are supported.				

6.2.3.2.3.3 GET

This method shall support the URI query parameters specified in table 6.2.3.2.3.3-1.

Table 6.2.3.2.3.3-1: URI query parameters supported by the GET method on this resource

Name	Data type	P	Cardinality	Description
supportedFeatures	SupportedFeatures	O	0..1	see 3GPP TS 29.500 [4] subclause 6.6

This method shall support the request data structures specified in table 6.2.3.2.3.3-2 and the response data structures and response codes specified in table 6.2.3.2.3.3-3.

Table 6.2.3.2.3.3-2: Data structures supported by the GET Request Body on this resource

Data type	P	Cardinality	Description
n/a			

Table 6.2.3.2.3.3-3: Data structures supported by the GET Response Body on this resource

Data type	P	Cardinality	Response codes	Description
Amf3GppAccessRegistration	M	1	200 OK	Upon success, a response body containing the Amf3GppAccessRegistration shall be returned.
NOTE: In addition common data structures as listed in table 6.2.7-1 are supported.				

6.2.3.3 Resource: AmfNon3GppAccessRegistration

6.2.3.3.1 Description

This resource represents the registered AMF for non 3GPP access.

6.2.3.3.2 Resource Definition

Resource URI: {apiRoot}/nudm-uecm/v1/{ueId}/registrations/amf-non-3gpp-access/

This resource shall support the resource URI variables defined in table 6.2.3.3.2-1.

Table 6.2.3.3.2-1: Resource URI variables for this resource

Name	Definition
apiRoot	See subclause 6.2.1
ueId	Represents the Subscription Identifier SUPI or GPSI (see 3GPP TS 23.501 [2] clause 5.9.2) SUPI (i.e. imsi or nai) is used with the PUT and PATCH methods; GPSI (i.e. msisdn or extid) is used with the GET method. pattern: "(imsi-[0-9]{5,15} nai-.[+] msisdn-[0-9]{5,15} extid-.[+])"

6.2.3.3.3 Resource Standard Methods

6.2.3.3.3.1 PUT

This method shall support the URI query parameters specified in table 6.2.3.3.3.1-1.

Table 6.2.3.3.3.1-1: URI query parameters supported by the PUT method on this resource

Name	Data type	P	Cardinality	Description
n/a				

This method shall support the request data structures specified in table 6.2.3.3.3.1-2 and the response data structures and response codes specified in table 6.2.3.3.3.1-3.

Table 6.2.3.3.3.1-2: Data structures supported by the PUT Request Body on this resource

Data type	P	Cardinality	Description
AmfNon3GppAccessRegistration	M	1	The AMF registration for non 3GPP access is replaced with the received information.

Table 6.2.3.3.3.1-3: Data structures supported by the PUT Response Body on this resource

Data type	P	Cardinality	Response codes	Description
n/a			204 No Content	Upon success, an empty response body shall be returned
NOTE: In addition common data structures as listed in table 6.2.7-1 are supported.				

6.2.3.3.3.2 PATCH

This method shall support the URI query parameters specified in table 6.2.3.3.3.2-1.

Table 6.2.3.3.3.2-1: URI query parameters supported by the PATCH method on this resource

Name	Data type	P	Cardinality	Description
n/a				

This method shall support the request data structures specified in table 6.2.3.3.3.2-2 and the response data structures and response codes specified in table 6.2.3.3.3.2-3.

Table 6.2.3.3.3.2-2: Data structures supported by the PATCH Request Body on this resource

Data type	P	Cardinality	Description
AmfNon3GppAccessRegistrationModification	M	1	The AMF registration for non 3GPP access is modified with the received information.

Table 6.2.3.3.3.2-3: Data structures supported by the PATCH Response Body on this resource

Data type	P	Cardinality	Response codes	Description
n/a			204 No Content	Upon success, an empty response body shall be returned
NOTE: In addition common data structures as listed in table 6.2.7-1 are supported.				

6.2.3.3.3.3 GET

This method shall support the URI query parameters specified in table 6.2.3.3.3.3-1.

Table 6.2.3.3.3.3-1: URI query parameters supported by the GET method on this resource

Name	Data type	P	Cardinality	Description
n/a				

This method shall support the request data structures specified in table 6.2.3.3.3.3-2 and the response data structures and response codes specified in table 6.2.3.3.3.3-3.

Table 6.2.3.3.3.3-2: Data structures supported by the GET Request Body on this resource

Data type	P	Cardinality	Description
n/a			

Table 6.2.3.3.3.3-3: Data structures supported by the GET Response Body on this resource

Data type	P	Cardinality	Response codes	Description
AmfNon3GppAccessRegistration	M	1	200 OK	Upon success, a response body containing the AmfNon3GppAccessRegistration shall be returned.
NOTE: In addition common data structures as listed in table 6.2.7-1 are supported.				

6.2.3.4 Resource: SmfRegistrations

6.2.3.4.1 Description

This resource is used to represent SMF registrations.

6.2.3.4.2 Resource Definition

Resource URI: {apiRoot}/nudm-uecm/v1/{ueId}/registrations/smf-registrations

This resource shall support the resource URI variables defined in table 6.2.3.4.2-1.

Table 6.2.3.4.2-1: Resource URI variables for this resource

Name	Definition
apiRoot	See subclause 6.4.1
ueId	Represents the Subscription Identifier SUPI or GPSI (see 3GPP TS 23.501 [2] clause 5.9.2) pattern: "(imsi-[0-9]{5,15} nai-+ msisdn-[0-9]{5,15} extid-+ .+)".

6.2.3.4.3 Resource Standard Methods

none

6.2.3.5 Resource: IndividualSmfRegistration

6.2.3.5.1 Resource Definition

Resource URI: {apiRoot}/nudm-uecm/v1/{ueId}/registrations/smf-registrations/{pduSessionId}

This resource shall support the resource URI variables defined in table 6.2.3.5.1-1.

Table 6.2.3.5.1-1: Resource URI variables for this resource

Name	Definition
apiRoot	See subclause 6.1.1
ueld	Represents the Subscription Identifier (see 3GPP TS 23.501 [2] clause 5.9.2) SUPI (i.e. imsi or nai) is used with the PUT, DELETE and PATCH methods; pattern: "(imsi-[0-9]{5,15} nai-.+ msisdn-[0-9]{5,15} extid-.+ .+)".
pduSessionId	The pduSessionId identifies an individual SMF registration.

6.2.3.5.2 Resource Standard Methods

6.2.3.5.2.1 PUT

This method shall support the URI query parameters specified in table 6.2.3.5.2.1-1.

Table 6.2.3.5.2.1-1: URI query parameters supported by the PUT method on this resource

Name	Data type	P	Cardinality	Description
n/a				

This method shall support the request data structures specified in table 6.2.3.5.2.1-2 and the response data structures and response codes specified in table 6.2.3.5.2.1-3.

Table 6.2.3.5.2.1-2: Data structures supported by the PUT Request Body on this resource

Data type	P	Cardinality	Description
SmfRegistration	M	1	The registration that is to be created

Table 6.2.3.5.2.1-3: Data structures supported by the PUT Response Body on this resource

Data type	P	Cardinality	Response codes	Description
SmfRegistration	M	1	201 Created	Upon success, a response body containing a representation of the created Individual SmfRegistration resource shall be returned.
NOTE: In addition common data structures as listed in table 6.4.7-1 are supported.				

6.2.3.5.2.2 DELETE

This method shall support the URI query parameters specified in table 6.2.3.5.2.2-1.

Table 6.2.3.5.2.2-1: URI query parameters supported by the DELETE method on this resource

Name	Data type	P	Cardinality	Description
n/a				

This method shall support the request data structures specified in table 6.2.3.5.2.2-2 and the response data structures and response codes specified in table 6.2.3.5.2.2-3.

Table 6.2.3.5.2.2-2: Data structures supported by the DELETE Request Body on this resource

Data type	P	Cardinality	Description
n/a			The request body shall be empty.

Table 6.2.3.5.2.2-3: Data structures supported by the DELETE Response Body on this resource

Data type	P	Cardinality	Response codes	Description
n/a			204 No Content	Upon success, an empty response body shall be returned.
NOTE: In addition common data structures as listed in table 6.4.7-1 are supported.				

6.2.3.6 Resource: Smsf3GppAccessRegistration

6.2.3.6.1 Description

This resource represents the registered SMSF for 3GPP access.

6.2.3.6.2 Resource Definition

Resource URI: {apiRoot}/nudm-uecm/v1/{ueId}/registrations/smsf-3gpp-access

This resource shall support the resource URI variables defined in table 6.2.3.6.2-1.

Table 6.2.3.6.2-1: Resource URI variables for this resource

Name	Definition
apiRoot	See subclause 6.2.1
ueId	Represents the Subscription Identifier SUPI or GPSI (see 3GPP TS 23.501 [2] clause 5.9.2) SUPI (i.e. imsi or nai) is used with the PUT, DELETE and PATCH methods; GPSI (i.e. msisdn or extid) is used with the GET method. pattern: "(imsi-[0-9]{5,15} nai-.+ msisdn-[0-9]{5,15} extid-.+ .+)"

6.2.3.6.3 Resource Standard Methods

6.2.3.6.3.1 PUT

This method shall support the URI query parameters specified in table 6.2.3.6.3.1-1.

Table 6.2.3.6.3.1-1: URI query parameters supported by the PUT method on this resource

Name	Data type	P	Cardinality	Description
n/a				

This method shall support the request data structures specified in table 6.2.3.6.3.1-2 and the response data structures and response codes specified in table 6.2.3.6.3.1-3.

Table 6.2.3.6.3.1-2: Data structures supported by the PUT Request Body on this resource

Data type	P	Cardinality	Description
SmsfRegistration	M	1	The SMSF registration for 3GPP access is created or updated with the received information.

Table 6.2.3.6.3.1-3: Data structures supported by the PUT Response Body on this resource

Data type	P	Cardinality	Response codes	Description
n/a			204 No Content	Upon success, an empty response body shall be returned
NOTE: In addition common data structures as listed in table 6.2.7-1 are supported.				

6.2.3.6.3.2 DELETE

This method shall support the URI query parameters specified in table 6.2.3.6.3.2-1.

Table 6.2.3.6.3.2-1: URI query parameters supported by the DELETE method on this resource

Name	Data type	P	Cardinality	Description
n/a				

This method shall support the request data structures specified in table 6.2.3.6.3.2-2 and the response data structures and response codes specified in table 6.2.3.6.3.2-3.

Table 6.2.3.6.3.2-2: Data structures supported by the DELETE Request Body on this resource

Data type	P	Cardinality	Description
n/a			The request body shall be empty.

Table 6.2.3.6.3.2-3: Data structures supported by the DELETE Response Body on this resource

Data type	P	Cardinality	Response codes	Description
n/a			204 No Content	Upon success, an empty response body shall be returned.
NOTE: In addition common data structures as listed in table 6.4.7-1 are supported.				

6.2.3.6.3.3 GET

This method shall support the URI query parameters specified in table 6.2.3.6.3.3-1.

Table 6.2.3.6.3.3-1: URI query parameters supported by the GET method on this resource

Name	Data type	P	Cardinality	Description
supportedFeatures	SupportedFeatures	O	0..1	see 3GPP TS 29.500 [4] subclause 6.6

This method shall support the request data structures specified in table 6.2.3.6.3.3-2 and the response data structures and response codes specified in table 6.2.3.6.3.3-3.

Table 6.2.3.6.3.3-2: Data structures supported by the GET Request Body on this resource

Data type	P	Cardinality	Description
n/a			

Table 6.2.3.6.3.3-3: Data structures supported by the GET Response Body on this resource

Data type	P	Cardinality	Response codes	Description
SmsfRegistration	M	1	200 OK	Upon success, a response body containing the SmsfRegistration shall be returned.
NOTE: In addition common data structures as listed in table 6.2.7-1 are supported.				

6.2.3.7 Resource: SmsfNon3GppAccessRegistration

6.2.3.7.1 Description

This resource represents the registered SMSF for non 3GPP access.

6.2.3.7.2 Resource Definition

Resource URI: {apiRoot}/nudm-uecm/v1/{ueId}/registrations/smsf-non-3gpp-access

This resource shall support the resource URI variables defined in table 6.2.3.7.2-1.

Table 6.2.3.7.2-1: Resource URI variables for this resource

Name	Definition
apiRoot	See subclause 6.2.1
ueId	Represents the Subscription Identifier SUPI or GPSI (see 3GPP TS 23.501 [2] clause 5.9.2) SUPI (i.e. imsi or nai) is used with the PUT, DELETE and PATCH methods; GPSI (i.e. msisdn or extid) is used with the GET method. pattern: "(imsi-[0-9]{5,15} nai-.+ msisdn-[0-9]{5,15} extid-.+ .+)"

6.2.3.7.3 Resource Standard Methods

6.2.3.7.3.1 PUT

This method shall support the URI query parameters specified in table 6.2.3.7.3.1-1.

Table 6.2.3.7.3.1-1: URI query parameters supported by the PUT method on this resource

Name	Data type	P	Cardinality	Description
n/a				

This method shall support the request data structures specified in table 6.2.3.7.3.1-2 and the response data structures and response codes specified in table 6.2.3.7.3.1-3.

Table 6.2.3.7.3.1-2: Data structures supported by the PUT Request Body on this resource

Data type	P	Cardinality	Description
SmsfRegistration	M	1	The SMSF registration for non 3GPP access is created or updated with the received information.

Table 6.2.3.7.3.1-3: Data structures supported by the PUT Response Body on this resource

Data type	P	Cardinality	Response codes	Description
n/a			204 No Content	Upon success, an empty response body shall be returned
NOTE: In addition common data structures as listed in table 6.2.7-1 are supported.				

6.2.3.7.3.2 DELETE

This method shall support the URI query parameters specified in table 6.2.3.7.2.2-1.

Table 6.2.3.7.2.2-1: URI query parameters supported by the DELETE method on this resource

Name	Data type	P	Cardinality	Description
n/a				

This method shall support the request data structures specified in table 6.2.3.7.2.2-2 and the response data structures and response codes specified in table 6.2.3.5.2.2-3.

Table 6.2.3.7.2.2-2: Data structures supported by the DELETE Request Body on this resource

Data type	P	Cardinality	Description
n/a			The request body shall be empty.

Table 6.2.3.7.2.2-3: Data structures supported by the DELETE Response Body on this resource

Data type	P	Cardinality	Response codes	Description
n/a			204 No Content	Upon success, an empty response body shall be returned.
NOTE: In addition common data structures as listed in table 6.4.7-1 are supported.				

6.2.3.7.3.3 GET

This method shall support the URI query parameters specified in table 6.2.3.7.3.3-1.

Table 6.2.3.7.3.3-1: URI query parameters supported by the GET method on this resource

Name	Data type	P	Cardinality	Description
supportedFeatures	SupportedFeatures	O	0..1	see 3GPP TS 29.500 [4] subclause 6.6

This method shall support the request data structures specified in table 6.2.3.7.3.3-2 and the response data structures and response codes specified in table 6.2.3.7.3.3-3.

Table 6.2.3.7.3.3-2: Data structures supported by the GET Request Body on this resource

Data type	P	Cardinality	Description
n/a			

Table 6.2.3.7.3.3-3: Data structures supported by the GET Response Body on this resource

Data type	P	Cardinality	Response codes	Description
SmsfRegistration	M	1	200 OK	Upon success, a response body containing the SmsfRegistration shall be returned.
NOTE: In addition common data structures as listed in table 6.2.7-1 are supported.				

6.2.4 Custom Operations without associated resources

In this release of this specification, no custom operations without associated resources are defined for the Nudm_UEContextManagement Service.

6.2.5 Notifications

6.2.5.1 General

This subclause will specify the use of notifications and corresponding protocol details if required for the specific service. When notifications are supported by the API, it will include a reference to the general description of notifications support over the 5G SBIs specified in TS 29.500 / TS 29.501.

6.2.5.2 Deregistration Notification

The POST method shall be used for Deregistration Notifications and the URI shall be as provided during the registration procedure.

Resource URI: {callbackReference}

Support of URI query parameters is specified in table 6.2.5.2-1.

Table 6.2.5.2-1: URI query parameters supported by the POST method

Name	Data type	P	Cardinality	Description
n/a				

Support of request data structures is specified in table 6.2.5.2-2 and of response data structures and response codes is specified in table 6.2.5.2-3.

Table 6.2.5.2-2: Data structures supported by the POST Request Body

Data type	P	Cardinality	Description
DeregistrationData	M	1	Includes Deregistration Reason

Table 6.2.5.2-3: Data structures supported by the POST Response Body

Data type	P	Cardinality	Response codes	Description
n/a			204 No Content	Upon success, an empty response body shall be returned.
NOTE: In addition common data structures as listed in table 6.1.7-1 are supported.				

6.2.5.3 P-CSCF Restoration Notification

The POST method shall be used for P-CSCF Restoration Notifications and the URI shall be as provided during the registration procedure.

Resource URI: {callbackReference}

Support of URI query parameters is specified in table 6.2.5.3-1.

Table 6.2.5.3-1: URI query parameters supported by the POST method

Name	Data type	P	Cardinality	Description
n/a				

Support of request data structures is specified in table 6.2.5.3-2 and of response data structures and response codes is specified in table 6.2.5.3-3.

Table 6.2.5.3-2: Data structures supported by the POST Request Body

Data type	P	Cardinality	Description
PcscfRestorationNotification	M	1	contains the SUPI

Table 6.2.5.3-3: Data structures supported by the POST Response Body

Data type	P	Cardinality	Response codes	Description
n/a			204 No Content	Upon success, an empty response body shall be returned.
NOTE: In addition common data structures as listed in table 6.1.7-1 are supported.				

6.2.6 Data Model

6.2.6.1 General

This subclause specifies the application data model supported by the API.

Editor's Note: It is ffs which data types should be specified in 3GPP TS 29.571.

Table 6.2.6.1-1 specifies the structured data types defined for the Nudm_UECM service API. For simple data types defined for the Nudm_UECM service API see table 6.2.6.3.2-1.

Table 6.2.6.1-1: Nudm_UECM specific Data Types

Data type	Section defined	Description
Amf3GppAccessRegistration	6.2.6.2.2	The complete set of information relevant to the AMF where the UE has registered via 3GPP access.
PurgeFlag	6.2.6.3.2	This flag indicates whether or not the NF has deregistered.
AmfNon3GppAccessRegistration	6.2.6.2.3	The complete set of information relevant to the AMF where the UE has registered via non 3GPP access.
DeregistrationData	6.2.6.2.5	Data sent with the Deregistration Notification
SmfRegistration	6.2.6.2.4	The complete set of information relevant to an SMF serving the UE
SmsfRegistration	6.2.6.2.6	The complete set of information relevant to the SMSF serving the UE.
Amf3GppAccessRegistrationModification	6.2.6.2.7	Contains attributes of Amf3GppAccessRegistration that can be modified using PATCH
AmfNon3GppAccessRegistrationModification	6.2.6.2.8	Contains attributes of AmfNon3GppAccessRegistration that can be modified using PATCH
PcscfRestorationNotification	6.2.6.2.9	Information sent to the AMF or SMF when P-CSCF restoration is triggered.

Table 6.2.6.1-2 specifies data types re-used by the Nudm_uecm service API from other specifications, including a reference to their respective specifications and when needed, a short description of their use within the Nudm_uecm service API.

Table 6.2.6.1-2: Nudm_UECM re-used Data Types

Data type	Reference	Comments
Dnn	3GPP TS 29.571 [7]	Data Network Name
NfInstanceId	3GPP TS 29.571 [7]	Network Function Instance Identifier
PduSessionId	3GPP TS 29.571 [7]	PDU Session ID
Pei	3GPP TS 29.571 [7]	Permanent Equipment Identifier
ProblemDetails	3GPP TS 29.571 [7]	Common data type used in response bodies
Uri	3GPP TS 29.571 [7]	Uniform Resource Identifier
SupportedFeatures	3GPP TS 29.571 [7]	see 3GPP TS 29.500 [4] subclause 6.6
Supi	3GPP TS 29.571 [7]	see 3GPP TS 23.501 [2] subclause 5.9.2

6.2.6.2 Structured data types

6.2.6.2.1 Introduction

This subclause defines the structures to be used in resource representations.

Allowed structures are: array, object.

6.2.6.2.2 Type: Amf3GppAccessRegistration

Table 6.2.6.2.2-1: Definition of type Amf3GppAccessRegistration

Attribute name	Data type	P	Cardinality	Description
amfld	NfInstanceId	M	1	Identifier of the serving AMF. It shall be formatted as a Globally Unique AMF ID, as defined in 3GPP TS 23.003 [8].
supportedFeatures	SupportedFeatures	O	0..1	See subclause 6.2.8
purgeFlag	PurgeFlag	O	0..1	This flag indicates whether or not the AMF has deregistered. It shall not be included in the Registration service operation.
pei	Pei	O	0..1	Permanent Equipment Identifier.
imsVoPS	ImsVoPS	O	0..1	Indicates per UE if "IMS Voice over PS Sessions" is homogeneously supported in all TAs in the serving AMF, or homogeneously not supported, or if support is non-homogeneous/unknown. Absence of this attribute shall be interpreted as "non homogenous or unknown" support.
deregCallbackUri	Uri	M	1	A URI provided by the AMF to receive (implicitly subscribed) notifications on deregistration.
pcscfRestorationCallbackUri	Uri	O	0..1	A URI provided by the AMF to receive (implicitly subscribed) notifications on the need for P-CSCF Restoration.
Optional attributes of this type that are also attributes of the derived type Amf3GppAccessRegistrationModification (see clause 6.2.6.2.7) shall not be marked with "nullable : true" in the OpenAPI file.				

6.2.6.2.3 Type: AmfNon3GppAccessRegistration

Table 6.2.6.2.3-1: Definition of type AmfNon3GppAccessRegistration

Attribute name	Data type	P	Cardinality	Description
amfld	NfInstanceId	M	1	Identifier of the serving AMF. It shall be formatted as a Globally Unique AMF ID, as defined in 3GPP TS 23.003 [8].
supportedFeatures	SupportedFeatures	O	0..1	See subclause 6.2.8
purgeFlag	PurgeFlag	O	0..1	This flag indicates whether or not the AMF has deregistered. It shall not be included in the Registration service operation.
pei	Pei	O	0..1	Permanent Equipment Identifier
deregCallbackUri	Uri	M	1	a URI provided by the AMF to receive (implicitly subscribed) notifications on deregistration
pcscfRestorationCallbackUri	Uri	O	0..1	A URI provided by the AMF to receive (implicitly subscribed) notifications on the need for P-CSCF Restoration.
Optional attributes of this type that are also attributes of the derived type AmfNon3GppAccessRegistrationModification (see clause 6.2.6.2.8) shall not be marked with "nullable : true" in the OpenAPI file.				

6.2.6.2.4 Type: SmfRegistration

Table 6.2.6.2.4-1: Definition of type SmfRegistration

Attribute name	Data type	P	Cardinality	Description
smfld	NfInstanceId	M	1	Identifier of the SMF
supportedFeatures	SupportedFeatures	O	0..1	See subclause 6.2.8
pduSessionId	PduSessionId	M	1	PDU Session ID
dnn	Dnn	M	1	Data Network Name
pcscfRestorationCallbackUri	Uri	O	0..1	a URI provided by the SMF to receive (implicitly subscribed) notifications on the need for P-CSCF Restoration
tbd				

6.2.6.2.5 Type: DeregistrationData

Table 6.2.6.2.5-1: Definition of type DeregistrationData

Attribute name	Data type	P	Cardinality	Description
deregReason	DeregistrationReason	M	1	String; see subclause 6.2.6.3.3
tbd				

6.2.6.2.6 Type: SmsfRegistration

Table 6.2.6.2.6-1: Definition of type SmsfRegistration

Attribute name	Data type	P	Cardinality	Description
smsfld	NfInstanceId	M	1	Identifier of the SMSF
supportedFeatures	SupportedFeatures	O	0..1	See subclause 6.2.8

6.2.6.2.7 Type: Amf3GppAccessRegistrationModification

This type is derived from the type Amf3GppAccessRestriction by deleting all attributes that are not subject to modification by means of the HTTP PATCH method.

Table 6.2.6.2.7-1: Definition of type Amf3GppAccessRegistrationModification

Attribute name	Data type	P	Cardinality	Description
purgeFlag	PurgeFlag	O	0..1	This flag indicates whether or not the AMF has deregistered. It shall be included in the Deregistration service operation with a value of "TRUE". This attribute is not marked "nullable: true" in the OpenAPI file as deletion of the attribute is not applicable.
pei	Pei	O	0..1	Permanent Equipment Identifier. This attribute is not marked "nullable: true" in the OpenAPI file as deletion of the attribute is not applicable.
imsVoPS	ImsVoPS	O	0..1	Indicates per UE if "IMS Voice over PS Sessions" is homogeneously supported in all TAs in the serving AMF, or homogeneously not supported, or if support is non-homogeneous/unknown. This attribute is not marked "nullable: true" in the OpenAPI file as deletion of the attribute is not applicable; rather it may be modified to the value "NON_HOMOGENEOUS_OR_UNKNOWN"
Absence of optional attributes indicates: no modification.				

6.2.6.2.8 Type: AmfNon3GppAccessRegistrationModification

This type is derived from the type Amf3NonGppAccessRestriction by deleting all attributes that are not subject to modification by means of the HTTP PATCH method. Optional attributes of this type shall be marked with "nullable : true" in the OpenAPI file.

Table 6.2.6.2.8-1: Definition of type AmfNon3GppAccessRegistrationModification

Attribute name	Data type	P	Cardinality	Description
purgeFlag	PurgeFlag	O	0..1	This flag indicates whether or not the AMF has deregistered. It shall be included in the Deregistration service operation with a value of "TRUE".
pei	Pei	O	0..1	Permanent Equipment Identifier
Optional attributes of this type shall be marked with "nullable : true" in the OpenAPI file.				

6.2.6.2.9 Type: PcscfRestorationNotification

Table 6.2.6.2.9-1: Definition of type PcscfRestorationNotification

Attribute name	Data type	P	Cardinality	Description
supi	Supi	M	1	A SUPI that is served by the failed P-CSCF

6.2.6.3 Simple data types and enumerations

6.2.6.3.1 Introduction

This subclause defines simple data types and enumerations that can be referenced from data structures defined in the previous subclauses.

6.2.6.3.2 Simple data types

The simple data types defined in table 6.2.6.3.2-1 shall be supported.

Table 6.2.6.3.2-1: Simple data types

Type Name	Type Definition	Description
PurgeFlag	boolean	This flag indicates whether or not the NF has deregistered.

6.2.6.3.3 Enumeration: DeregistrationReason

The enumeration DeregistrationReason represents the reason for the Deregistration Notification. It shall comply with the provisions defined in table 6.2.6.3.3-1.

Table 6.2.6.3.3-1: Enumeration DeregistrationReason

Enumeration value	Description
"UE_INITIAL_REGISTRATION"	see 3GPP TS 23.502 [3]
"UE_REGISTRATION_AREA_CHANGE"	see 3GPP TS 23.502 [3]
"SUBSCRIPTION_WITHDRAWN"	see 3GPP TS 23.502 [3]
"5GS_TO_EPS_MOBILITY"	see 3GPP TS 23.502 [3]

6.2.6.3.4 Enumeration: ImsVoPS

The enumeration ImsVoPS represents information indicating homogeneity of IMS Voice over PS Sessions support for the UE. It shall comply with the provisions defined in table 6.2.6.3.4-1.

Table 6.2.6.3.4-1: Enumeration ImsVoPS

Enumeration value	Description
"HOMOGENEOUS_SUPPORT"	"IMS Voice over PS Sessions" is homogeneously supported in all TAs in the serving AMF.
"HOMOGENEOUS_NON_SUPPORT"	"IMS Voice over PS Sessions" is homogeneously not supported in all TAs in the serving AMF.
"NON_HOMOGENEOUS_OR_UNKNOWN"	"IMS Voice over PS Sessions" is not homogeneously supported in all TAs in the serving AMF, or its support is unknown.

6.2.7 Error Handling

Table 6.2.7-1 lists common response body data structures used within the nudm_uecm API

Table 6.2.7-1: Common Response Body Data Structures

Data type	P	Cardinality	Response codes	Description
NOTE: In addition common data structures as defined in 3GPP TS 29.500 [4] are supported.				

6.2.8 Feature Negotiation

The optional features in table 6.2.8-1 are defined for the Nudm_UECM API. They shall be negotiated using the extensibility mechanism defined in subclause 6.6 of 3GPP TS 29.500 [4].

Table 6.2.8-1: Supported Features

Feature number	Feature Name	Description

Editor's Note: The concept of supportedFeatures as query parameter in GET requests needs to be confirmed and described in TS 29.500.

6.2.9 Security

As indicated in 3GPP TS 33.501 [6], the access to the Nudm_UECM API shall be authorized by means of the OAuth2 protocol (see IETF RFC 6749 [18]), using the "Client Credentials" authorization grant, where the NRF (see 3GPP TS 29.510 [19]) plays the role of the authorization server.

An NF Service Consumer, prior to consuming services offered by the Nudm_UECM API, shall obtain a "token" from the authorization server, by invoking the Access Token Request service, as described in 3GPP TS 29.510 [19], subclause 5.4.2.2.

NOTE: When multiple NRFs are deployed in a network, the NRF used as authorization server is the same NRF that the NF Service Consumer used for discovering the Nudm_UECM service.

The Nudm_UECM API does not define any scopes for OAuth2 authorization.

6.3 Nudm_UEAuthentication Service API

6.3.1 API URI

URIs of this API shall have the following root:

```
{apiRoot}/{apiName}/{apiVersion}/
```

where the "apiName" shall be set to "nudm-uecm" and the "apiVersion" shall be set to "v1" for the current version of this specification.

6.3.2 Usage of HTTP

6.3.2.1 General

HTTP/2, as defined in IETF RFC 7540 [13], shall be used as specified in clause 5 of 3GPP TS 29.500 [4].

HTTP/2 shall be transported as specified in subclause 5.3 of 3GPP TS 29.500 [4].

HTTP messages and bodies for the Nudm_UEAU service shall comply with the OpenAPI [14] specification contained in Annex A4.

6.3.2.2 HTTP standard headers

6.3.2.2.1 General

The usage of HTTP standard headers shall be supported as specified in subclause 5.2.2 of 3GPP TS 29.500 [4].

6.3.2.2.2 Content type

The following content types shall be supported:

JSON, as defined in IETF RFC 8259 [15], signalled by the content type "application/json".

The Problem Details JSON Object (IETF RFC 7807 [16]) signalled by the content type "application/problem+json".

6.3.2.3 HTTP custom headers

6.3.2.3.1 General

The usage of HTTP custom headers shall be supported as specified in subclause 5.2.3 of 3GPP TS 29.500 [4].

6.3.3 Resources

6.3.3.1 Overview

Figure 6.3.3.1-1 describes the resources supported by the Nudm_UEAU API.

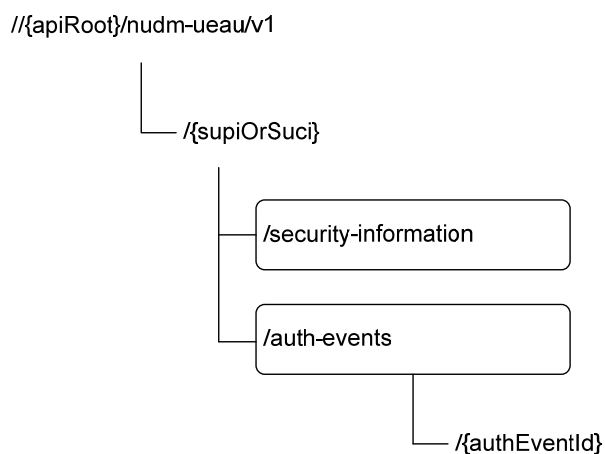

Figure 6.3.3.1-1: Resource URI structure of the nudm_ueau API

Table 6.3.3.1-1 provides an overview of the resources and applicable HTTP methods.

Table 6.3.3.1-1: Resources and methods overview

Resource name (Archetype)	Resource URI	HTTP method or custom operation	Description
SecurityInformation (Custom operation)	/s{supiOrSuci}/security-information/generate-auth-data	generate-auth-data (POST)	If the variable {supiOrSuci} takes the value of a SUCI, the UDM calculates the corresponding SUPI. The UDM calculates a fresh authentication vector based on the received information and the stored security information for the SUPI if 5G-AKA or EAP-AKA' is selected. Otherwise, UDM provides corresponding authentication information.
AuthEvents (Collection)	/s{supi}/auth-events	POST	Create an Authentication Event

6.3.3.2 Resource: SecurityInformation

6.3.3.2.1 Description

This resource represents the information that is needed together with the serving network name and the access type to calculate a fresh authentication vector. See 3GPP TS 33.501 [6].

6.3.3.2.2 Resource Definition

Resource URI: {apiRoot}/nudm-ueau/v1/{supiOrSuci}/security-information

This resource shall support the resource URI variables defined in table 6.3.3.2.2-1.

Table 6.3.3.2.2-1: Resource URI variables for this resource

Name	Definition
apiRoot	See subclause 6.3.1
supiOrSuci	Represents the Subscription Permanent Identifier (see 3GPP TS 23.501 [2] subclause 5.9.2), or Subscription Concealed Identifier (see 3GPP TS 23.003 [8]) pattern: "(imsi-[0-9]{5,15}nai-.+ suci-[0-9]{5,6}-[0-9]{1,4}-[a-fA-F0-9]-(NULL [a-zA-Z0-9]+)-[a-fA-F0-9]+ .+)")"

6.3.3.2.3 Resource Standard Methods

No Standard Methods are supported for this resource.

6.3.3.2.4 Resource Custom Operations

6.3.3.2.4.1 Overview

Table 6.3.3.2.4.1-1: Custom operations

Custom operation URI	Mapped HTTP method	Description
/generate-auth-data	POST	Select the authentication method and calculate a fresh AV if 5G-AKA or EAP-AKA' is selected or provides corresponding authentication information.

6.3.3.2.4.2 Operation: generate-auth-data

6.3.3.2.4.2.1 Description

This custom operation is used by the NF service consumer (AUSF) to request authentication information data for the SUPI/SUCI from the UDM. If SUCI is provided, the UDM calculates the SUPI from the SUCI (see 3GPP TS 33.501 [6]). The UDM calculates an authentication vector taking into account the information received from the NF service consumer (AUSF) and the current representation of this resource if 5G AKA or EAP-AKA' is selected. For details see 3GPP TS 33.501 [6].

6.3.3.2.4.2.2 Operation Definition

This operation shall support the request data structures specified in table 6.3.3.2.4.2.2-1 and the response data structure and response codes specified in table 6.3.3.2.4.2.2-2.

Table 6.3.3.2.4.2.2-1: Data structures supported by the POST Request Body on this resource

Data type	P	Cardinality	Description
AuthenticationInfo Request	M	1	Contains the serving network name and Resynchronization Information

Table 6.3.3.2.4.2.2-2: Data structures supported by the POST Response Body on this resource

Data type	P	Cardinality	Response codes	Description
AuthenticationInfoResult	M	1	200 OK	Upon success, a response body containing the selected authentication method and an authentication vector if 5G AKA or EAP-AKA' has been selected shall be returned
NOTE: In addition common data structures as listed in table 6.1.7-1 are supported.				

6.3.3.3 Resource: AuthEvents

6.3.3.3.1 Description

This resource represents the collection of UE authentication events.

6.3.3.3.2 Resource Definition

Resource URI: {apiRoot}/nudm-ueau/v1/{supi}/auth-events

This resource shall support the resource URI variables defined in table 6.3.3.3.2-1.

Table 6.3.3.3.2-1: Resource URI variables for this resource

Name	Definition
apiRoot	See subclause 6.3.1
supi	Represents the Subscription Permanent Identifier (see 3GPP TS 23.501 [2] subclause 5.9.2) pattern: "(imsi-[0-9]{5,15})nai-+.+)"

6.3.3.3.3 Resource Standard Methods

6.3.3.3.3.1 POST

This method shall support the URI query parameters specified in table 6.3.3.3.3.1-1.

Table 6.3.3.3.3.1-1: URI query parameters supported by the POST method on this resource

Name	Data type	P	Cardinality	Description
n/a				

This method shall support the request data structures specified in table 6.3.3.3.3.1-2 and the response data structures and response codes specified in table 6.3.3.3.3.1-3.

Table 6.3.3.3.3.1-2: Data structures supported by the POST Request Body on this resource

Data type	P	Cardinality	Description
AuthEvent	M	1	The UE Authentication Event

Table 6.3.3.3.3.1-3: Data structures supported by the POST Response Body on this resource

Data type	P	Cardinality	Response codes	Description
AuthEvent	O	0..1	201 Created	Upon success, a response body containing a representation of the created Authentication Event may be returned. The HTTP response shall include a "Location" HTTP header that contains the resource URI of the created resource.

NOTE: In addition common data structures as listed in table 6.3.7-1 are supported.

6.3.4 Custom Operations without associated resources

In this release of this specification, no custom operations without associated resources are defined for the Nudm_UEAuthentication Service.

6.3.5 Notifications

In this release of this specification, no notifications are defined for the Nudm_UEAuthentication Service.

6.3.6 Data Model

6.3.6.1 General

This subclause specifies the application data model supported by the API.

Editor's Note: It is ffs which data types should be specified in 3GPP TS 29.571.

Table 6.3.6.1-1 specifies the structured data types defined for the Nudm_UEAU service API. For simple data types defined for the Nudm_UEAU service API see table 6.3.6.3.2-1.

Table 6.3.6.1-1: Nudm_UEAU specific Data Types

Data type	Section defined	Description
AuthenticationInfoRequest	6.3.6.2.2	Contains Serving Network Name and Resynchronization Information
AuthenticationInfoResult	6.3.6.2.3	Contains an Authentication Vector (AV)
AvEapAkaPrime	6.3.6.2.4	Contains RAND, XRES, AUTN, CK', and IK'
Av5GHeAka	6.3.6.2.5	Contains RAND, XRES*, AUTN, KAUSF
AuthEvent	6.3.6.2.7	Authentication Event
ResynchronizationInfo	6.3.6.2.6	Contains RAND and AUTS
AuthenticationVector	6.3.6.2.8	

Table 6.3.6.1-2 specifies data types re-used by the Nudm_UEAU service API from other specifications, including a reference to their respective specifications and when needed, a short description of their use within the Nudm_UEAU service API.

Table 6.3.6.1-2: Nudm_UEAU re-used Data Types

Data type	Reference	Comments
ProblemDetails	3GPP TS 29.571 [7]	Common data type used in response bodies
NfInstanceId	3GPP TS 29.571 [7]	Network Function Instance Identifier
DateTime	3GPP TS 29.571 [7]	
SupportedFeatures	3GPP TS 29.571 [7]	see 3GPP TS 29.500 [4] subclause 6.6
Supi	3GPP TS 29.571 [7]	

6.3.6.2 Structured data types

6.3.6.2.1 Introduction

This subclause defines the structures to be used in POST request / response bodies.

Allowed structures are: array, object.

6.3.6.2.2 Type: AuthenticationInfoRequest

Table 6.3.6.2.2-1: Definition of type AuthenticationInfoRequest

Attribute name	Data type	P	Cardinality	Description
servingNetworkName	ServingNetworkName	M	1	See 3GPP TS 33.501 [6] subclause 6.1.1.3
resynchronizationInfo	ResynchronizationInfo	O	0..1	Contains RAND and AUTS; see 3GPP TS 33.501 [6] subclause 7.5
supportedFeatures	SupportedFeatures	O	0..1	See subclause 6.3.8

6.3.6.2.3 Type: AuthenticationInfoResult

Table 6.3.6.2.3-1: Definition of type AuthenticationInfoResult

Attribute name	Data type	P	Cardinality	Description
authType	AuthType	M	1	Indicates the authentication method
authenticationVector	AuthenticationVector	C	0..1	contains an authentication vector if 5G AKA or EAP-AKA's is selected
supi	Supi	C	0..1	SUPI shall be present if the request contained the SUCI within the request URI
supportedFeatures	SupportedFeatures	O	0..1	See subclause 6.3.8

6.3.6.2.4 Type: AvEapAkaPrime

Table 6.3.6.2.4-1: Definition of type AvEapAkaPrime

Attribute name	Data type	P	Cardinality	Description
avType	AvType	M	1	Type of authentication vector
rand	Rand	M	1	
xres	Xres	M	1	
autn	Autn	M	1	
ckPrime	CkPrime	M	1	
ikPrime	IkPrime	M	1	

6.3.6.2.5 Type: Av5GHeAka

Table 6.3.6.2.5-1: Definition of type Av5GAka

Attribute name	Data type	P	Cardinality	Description
avType	AvType	M	1	Type of authentication vector
rand	Rand	M	1	
xresStar	XresStar	M	1	
autn	Autn	M	1	
kauf	Kauf	M	1	

6.3.6.2.6 Type: ResynchronizationInfo

Table 6.3.6.2.6-1: Definition of type ResynchronizationInfo

Attribute name	Data type	P	Cardinality	Description
rand	Rand	M	1	
auts	Auts	M	1	

6.3.6.2.7 Type: AuthEvent

Table 6.3.6.2.7-1: Definition of type AuthEvent

Attribute name	Data type	P	Cardinality	Description
nfInstanceId	NfInstanceId	M	1	Identifier of the NF instance where the authentication occurred
success	Success	M	1	true indicates success; false indicates no success
timeStamp	DateTime	M	1	time stamp of the authentication
authType	AuthType	M	1	string Authentication Type ("EAP_AKA_PRIME" or "5G_AKA")

6.3.6.2.8 Type: AuthenticationVector

Table 6.3.6.2.8-1: Definition of type AuthenticationVector as a list of alternatives

Data type	Cardinality	Description
AvEapAkaPrime	1	
Av5GHeAka	1	

6.3.6.3 Simple data types and enumerations

6.3.6.3.1 Introduction

This subclause defines simple data types and enumerations that can be referenced from data structures defined in the previous subclauses.

6.3.6.3.2 Simple data types

The simple data types defined in table 6.3.6.3.2-1 shall be supported.

Table 6.3.6.3.2-1: Simple data types

Type Name	Type Definition	Description
Autn	string	pattern: "[A-Fa-f0-9]{32}"
Auts	string	pattern: "[A-Fa-f0-9]{28}"
CkPrime	string	pattern: "[A-Fa-f0-9]{32}"
IkPrime	string	pattern: "[A-Fa-f0-9]{32}"
Kausf	string	pattern: "[A-Fa-f0-9]{64}"
Rand	string	pattern: "[A-Fa-f0-9]{32}"
ServingNetworkName	string	See 3GPP TS 33.501 [6] subclause 6.1.1.3
Success	boolean	true indicates success, false indicates no success
Xres	string	pattern: "[A-Fa-f0-9]{8,32}"
XresStar	string	pattern: "[A-Fa-f0-9]{32}"

6.3.6.3.3 Enumeration: AuthType

Table 6.3.6.3.3-1: Enumeration AuthType

Enumeration value	Description
"EAP_AKA_PRIME"	EAP-AKA'
"5G_AKA"	5G AKA
"EAP_TLS"	EAP-TLS. See NOTE
NOTE: EAP-TLS is described in the Informative Annex B of 3GPP TS 33.501 [6] and is not mandatory to support.	

6.3.6.3.4 Enumeration: AvType

Table 6.3.6.3.4-1: Enumeration AvType

Enumeration value	Description
"5G_HE_AKA"	
"EAP_AKA_PRIME"	

6.3.7 Error Handling

Table 6.3.7-1 lists common response body data structures used within the nudm_ueau API

Table 6.3.7-1: Common Response Body Data Structures

Data type	P	Cardinality	Response codes	Description
NOTE: In addition common data structures as defined in 3GPP TS 29.500 [4] are supported.				

6.3.8 Feature Negotiation

The optional features in table 6.3.8-1 are defined for the Nudm_UEAU API. They shall be negotiated using the extensibility mechanism defined in subclause 6.6 of 3GPP TS 29.500 [4].

Table 6.3.8-1: Supported Features

Feature number	Feature Name	Description

6.3.9 Security

As indicated in 3GPP TS 33.501 [6], the access to the Nudm_UEAU API shall be authorized by means of the OAuth2 protocol (see IETF RFC 6749 [18]), using the "Client Credentials" authorization grant, where the NRF (see 3GPP TS 29.510 [19]) plays the role of the authorization server.

An NF Service Consumer, prior to consuming services offered by the Nudm_UEAU API, shall obtain a "token" from the authorization server, by invoking the Access Token Request service, as described in 3GPP TS 29.510 [19], subclause 5.4.2.2.

NOTE: When multiple NRFs are deployed in a network, the NRF used as authorization server is the same NRF that the NF Service Consumer used for discovering the Nudm_UEAU service.

The Nudm_UEAU API does not define any scopes for OAuth2 authorization.

6.4 Nudm_EventExposure Service API

6.4.1 API URI

URIs of this API shall have the following root:

```
{apiRoot}/{apiName}/{apiVersion}/
```

where the "apiName" shall be set to "nudm-ee" and the "apiVersion" shall be set to "v1" for the current version of this specification.

6.4.2 Usage of HTTP

6.4.2.1 General

HTTP/2, as defined in IETF RFC 7540 [13], shall be used as specified in clause 5 of 3GPP TS 29.500 [4].

HTTP/2 shall be transported as specified in subclause 5.3 of 3GPP TS 29.500 [4].

HTTP messages and bodies for the Nudm_EE service shall comply with the OpenAPI [14] specification contained in Annex A5.

6.4.2.2 HTTP standard headers

6.4.2.2.1 General

The usage of HTTP standard headers shall be supported as specified in subclause 5.2.2 of 3GPP TS 29.500 [4].

6.4.2.2.2 Content type

The following content types shall be supported:

JSON, as defined in IETF RFC 8259 [15], signalled by the content type "application/json".

The Problem Details JSON Object (IETF RFC 7807 [16]) signalled by the content type "application/problem+json"

6.4.2.3 HTTP custom headers

6.4.2.3.1 General

The usage of HTTP custom headers shall be supported as specified in subclause 5.2.3 of 3GPP TS 29.500 [4].

6.4.3 Resources

6.4.3.1 Overview

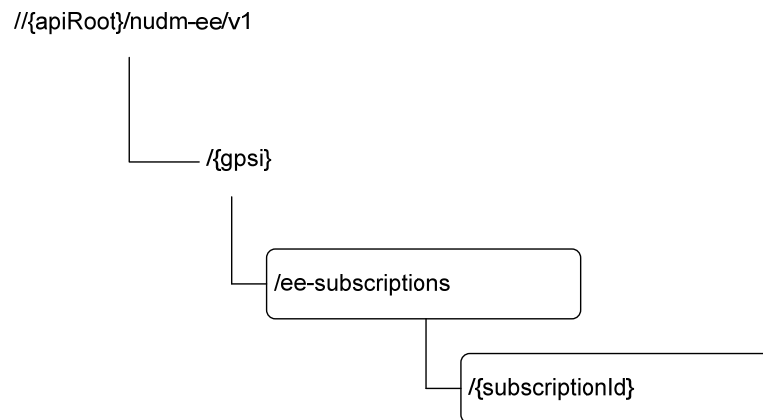

Figure 6.4.3.1-1: Resource URI structure of the Nudm_EE API

Table 6.4.3.1-1 provides an overview of the resources and applicable HTTP methods.

Table 6.4.3.1-1: Resources and methods overview

Resource name (Archetype)	Resource URI	HTTP method or custom operation	Description
EeSubscriptions (Collection)	/{gpsi}/ee-subscriptions	POST	Create a subscription
Individual subscription (Document)	/{gpsi}/ee-subscriptions/{subscriptionId}	DELETE	Delete the subscription identified by {subscriptionId}, i.e. unsubscribe

6.4.3.2 Resource: EeSubscriptions

6.4.3.2.1 Description

This resource is used to represent subscriptions to notifications.

6.4.3.2.2 Resource Definition

Resource URI: {apiRoot}/nudm-ee/v1/{gpsi}/ee-subscriptions

This resource shall support the resource URI variables defined in table 6.4.3.2.2-1.

Table 6.4.3.2.2-1: Resource URI variables for this resource

Name	Definition
apiRoot	See subclause 6.4.1
gpsi	Represents the Generic Public Subscription Identifier (see 3GPP TS 23.501 [2] subclause 5.9.8) pattern: "(msisdn-[0-9]{5,15})ext-id-.[@.+.+)"

6.4.3.2.3 Resource Standard Methods

6.4.3.2.3.1 POST

This method shall support the URI query parameters specified in table 6.4.3.2.3.1-1.

Table 6.4.3.2.3.1-1: URI query parameters supported by the POST method on this resource

Name	Data type	P	Cardinality	Description
n/a				

This method shall support the request data structures specified in table 6.4.3.2.3.1-2 and the response data structures and response codes specified in table 6.4.3.2.3.1-3.

Table 6.4.3.2.3.1-2: Data structures supported by the POST Request Body on this resource

Data type	P	Cardinality	Description
EeSubscription	M	1	The subscription that is to be created

Table 6.4.3.2.3.1-3: Data structures supported by the POST Response Body on this resource

Data type	P	Cardinality	Response codes	Description
EeSubscription	M	1	201 Created	Upon success, a response body containing a representation of the created Individual subscription resource shall be returned. The HTTP response shall include a "Location" HTTP header that contains the resource URI of the created resource. When stateless UDM is deployed, the stateless UDM shall use the FQDN identifying the UDM set to which the UDM belongs as the host part of the resource URI.
NOTE: In addition common data structures as listed in table 6.4.7-1 are supported.				

NOTE: In the scenario of stateless UDM deployment, it is assumed that stateless UDMs are organized into several UDM sets, and each UDM set is allocated an FQDN.

6.4.3.3 Resource: Individual subscription

6.4.3.3.1 Resource Definition

Resource URI: {apiRoot}/nudm-ee/v1/{gpsid}/ee-subscriptions/{subscriptionId}

This resource shall support the resource URI variables defined in table 6.4.3.3.1-1.

Table 6.4.3.3.1-1: Resource URI variables for this resource

Name	Definition
apiRoot	See subclause 6.1.1
gpsid	Represents the Generic Public Subscription Identifier (see 3GPP TS 23.501 [2] subclause 5.9.8) pattern: "(msisdn-[0-9]{5,15} ext-id-+@.+ .+)")
subscriptionId	The subscriptionId identifies an individual subscription to notifications. The value is allocated by the UDM during creation of the Subscription resource.

6.4.3.3.1 Resource Standard Methods

6.4.3.3.1.1 DELETE

This method shall support the URI query parameters specified in table 6.4.3.3.1.1-1.

Table 6.4.3.3.1.1-1: URI query parameters supported by the DELETE method on this resource

Name	Data type	P	Cardinality	Description
n/a				

This method shall support the request data structures specified in table 6.4.3.3.1.1-2 and the response data structures and response codes specified in table 6.4.3.3.1.1-3.

Table 6.4.3.3.1.1-2: Data structures supported by the Delete Request Body on this resource

Data type	P	Cardinality	Description
n/a			The request body shall be empty.

Table 6.4.3.3.1.1-3: Data structures supported by the DELETE Response Body on this resource

Data type	P	Cardinality	Response codes	Description
n/a			204 No Content	Upon success, an empty response body shall be returned.

NOTE: In addition common data structures as listed in table 6.4.7-1 are supported.

6.4.4 Custom Operations without associated resources

In this release of this specification, no custom operations without associated resources are defined for the Nudm_EventExposure Service.

6.4.5 Notifications

6.4.5.1 General

This subclause will specify the use of notifications and corresponding protocol details if required for the specific service. When notifications are supported by the API, it will include a reference to the general description of notifications support over the 5G SBIs specified in TS 29.500 / TS 29.501.

6.4.5.2 Event Occurrence Notification

The POST method shall be used for Event Occurrence Notifications and the URI shall be as provided during the subscription procedure.

Resource URI: {callbackReference}

Support of URI query parameters is specified in table 6.4.5.2-1.

Table 6.4.5.2-1: URI query parameters supported by the POST method

Name	Data type	P	Cardinality	Description
n/a				

Support of request data structures is specified in table 6.4.5.2-2 and of response data structures and response codes is specified in table 6.4.5.2-3.

Table 6.4.5.2-2: Data structures supported by the POST Request Body

Data type	P	Cardinality	Description
MonitoringReport	M	1	contains information regarding the occurred event

Table 6.2.5.2-3: Data structures supported by the POST Response Body

Data type	P	Cardinality	Response codes	Description
n/a			204 No Content	Upon success, an empty response body shall be returned.
NOTE: In addition common data structures as listed in table 6.1.7-1 are supported.				

6.4.6 Data Model

6.4.6.1 General

This subclause specifies the application data model supported by the API.

Editor's Note: It is ffs which data types should be specified in 3GPP TS 29.571.

Table 6.4.6.2-1 specifies the data types defined for the Nudm_EE service API.

Table 6.4.6.1-1: Nudm_EE specific Data Types

Data type	Section defined	Description
EeSubscription	6.4.6.2.2	A subscription to Notifications
MonitoringConfiguration	6.4.6.2.3	Monitoring Configuration
MonitoringReport	6.4.6.2.4	Monitoring Report
Report	6.4.6.2.5	
ReportingOptions	6.4.6.2.6	
ChangeOfSupiPeiAssociationReport	6.4.6.2.7	
RoamingStatusReport	6.4.6.2.8	

Table 6.4.6.1-2 specifies data types re-used by the Nudm_EE service API from other specifications, including a reference to their respective specifications and when needed, a short description of their use within the Nudm_EE service API.

Table 6.4.6.1-2: Nudm_EE re-used Data Types

Data type	Reference	Comments
Uri	3GPP TS 29.571 [7]	Uniform Resource Identifier
SupportedFeatures	3GPP TS 29.571 [7]	see 3GPP TS 29.500 [4] subclause 6.6
DateTime	3GPP TS 29.571 [7]	
Pei	3GPP TS 29.571 [7]	
PlmnId	3GPP TS 29.571 [7]	

6.4.6.2 Structured data types

6.4.6.2.1 Introduction

This subclause defines the structures to be used in resource representations.

Allowed structures are: array, object.

6.4.6.2.2 Type: EeSubscription

Table 6.4.6.2.2-1: Definition of type EeSubscription

Attribute name	Data type	P	Cardinality	Description
callbackReference	Uri	M	1	URI provided by the NF service consumer to receive notifications
monitoringConfiguration	map(Monitoring Configuration)	M	1..N	A map (list of key-value pairs where referenceld converted from integer to string serves as key) of MonitoringConfigurations; see subclause 6.4.6.2.3
supportedFeatures	SupportedFeatures	O	0..1	See subclause 6.4.8

6.4.6.2.3 Type: MonitoringConfiguration

Table 6.4.6.2.3-1: Definition of type MonitoringConfiguration

Attribute name	Data type	P	Cardinality	Description
referenceld	Referenceld	M	1	Reference Id uniquely identifies the Monitoring Configuration
eventType	EventType	M	1	String; see subclause 6.4.6.3.3
reportingOptions	ReportingOptions	M	1	

6.4.6.2.4 Type: MonitoringReport

Table 6.4.6.2.4-1: Definition of type MonitoringReport

Attribute name	Data type	P	Cardinality	Description
referenceld	Referenceld	M	1	
eventType	EventType	M	1	String; see subclause 6.4.6.3.3 only the following values are allowed: "UE_REACHABILITY_FOR_SMS" "CHANGE_OF_SUPI_PEI_ASSOCIATION" "ROAMING_STATUS"
report	Report	C	0..1	Shall be present if eventType is "CHANGE_OF_SUPI_PEI_ASSOCIATION" or "ROAMING_STATUS"

6.4.6.2.5 Type: Report

Table 6.4.6.2.5-1: Definition of type Report as a list of alternatives

Data type	Cardinality	Description
ChangeOfSupiPeiAssociationReport	1	
RoamingStatusReport	1	

6.4.6.2.6 Type: ReportingOptions

Table 6.4.6.2.6-1: Definition of type ReportingOptions

Attribute name	Data type	P	Cardinality	Description
maxNumOfReports	MaxNumOfReports	O	0..1	Maximum number of reports
monitoringDuration	DateTime	O	0..1	Point in time at which monitoring shall cease

6.4.6.2.7 Type: ChangeOfSupiPeiAssociationReport

Table 6.4.6.2.7-1: Definition of type ChangeOfSupiPeiAssociationReport

Attribute name	Data type	P	Cardinality	Description
newPei	Pei	M	1	the new PEI

6.4.6.2.8 Type: RoamingStatusReport

Table 6.4.6.2.8-1: Definition of type RoamingStatusReport

Attribute name	Data type	P	Cardinality	Description
roaming	boolean	M	1	True: The new serving PLMN is different from the HPLMN; False: The new serving PLMN is the HPLMN
newServingPlmn	PlmnId	M	1	the new Serving PLMN

6.4.6.3 Simple data types and enumerations

6.4.6.3.1 Introduction

This subclause defines simple data types and enumerations that can be referenced from data structures defined in the previous subclauses.

6.4.6.3.2 Simple data types

The simple data types defined in table 6.4.6.3.2-1 shall be supported.

Table 6.4.6.3.2-1: Simple data types

Type Name	Type Definition	Description
MaxNumOfReports	integer	Maximum number of reports. Minimum: 1
Referenceld	integer	

6.4.6.3.3 Enumeration: EventType

Table 6.4.6.3.3-1: Enumeration EventType

Enumeration value	Description
"LOSS_OF_CONNECTIVITY"	Loss of connectivity
"UE_REACHABILITY_FOR_DATA"	UE reachability for data
"UE_REACHABILITY_FOR_SMS"	UE reachability for SMS
"LOCATION_REPORTING"	Location Reporting
"CHANGE_OF_SUP_I_PEI_ASSOCIATION"	Change of SUPI-PEI association
"ROAMING_STATUS"	Roaming Status
"COMMUNICATION_FAILURE"	Communication Failure
"AVAILABILITY_AFTER_DNN_FAILURE"	Availability after DNN failure

6.4.7 Error Handling

Table 6.4.7-1 lists common response body data structures used within the nudm_ee API

Table 6.4.7-1: Common Response Body Data Structures

Data type	P	Cardinality	Response codes	Description
NOTE: In addition common data structures as defined in 3GPP TS 29.500 [4] are supported.				

6.4.8 Feature Negotiation

The optional features in table 6.4.8-1 are defined for the Nudm_EE API. They shall be negotiated using the extensibility mechanism defined in subclause 6.6 of 3GPP TS 29.500 [4].

Table 6.4.8-1: Supported Features

Feature number	Feature Name	Description

6.4.9 Security

As indicated in 3GPP TS 33.501 [6], the access to the Nudm_EE API shall be authorized by means of the OAuth2 protocol (see IETF RFC 6749 [18]), using the "Client Credentials" authorization grant, where the NRF (see 3GPP TS 29.510 [19]) plays the role of the authorization server.

An NF Service Consumer, prior to consuming services offered by the Nudm_EE API, shall obtain a "token" from the authorization server, by invoking the Access Token Request service, as described in 3GPP TS 29.510 [19], subclause 5.4.2.2.

NOTE: When multiple NRFs are deployed in a network, the NRF used as authorization server is the same NRF that the NF Service Consumer used for discovering the Nudm_EE service.

The Nudm_EE API does not define any scopes for OAuth2 authorization.

6.5 Nudm_ParameterProvision Service API

6.5.1 API URI

URIs of this API shall have the following root:

{apiRoot}/{apiName}/{apiVersion}/

where the "apiName" shall be set to "nudm-pp" and the "apiVersion" shall be set to "v1" for the current version of this specification.

6.5.2 Usage of HTTP

6.5.2.1 General

HTTP/2, as defined in IETF RFC 7540 [13], shall be used as specified in clause 5 of 3GPP TS 29.500 [4].

HTTP/2 shall be transported as specified in subclause 5.3 of 3GPP TS 29.500 [4].

HTTP messages and bodies for the Nudm_PP service shall comply with the OpenAPI [14] specification contained in Annex A6.

6.5.2.2 HTTP standard headers

6.5.2.2.1 General

The usage of HTTP standard headers shall be supported as specified in subclause 5.2.2 of 3GPP TS 29.500 [4].

6.5.2.2.2 Content type

The following content types shall be supported:

JSON, as defined in IETF RFC 8259 [15], signalled by the content type "application/json".

The Problem Details JSON Object (IETF RFC 7807 [16] signalled by the content type "application/problem+json" JSON Merge Patch, as defined in IETF RFC 7396 [17], signalled by the content type "application/merge-patch+json"

6.5.2.3 HTTP custom headers

6.5.2.3.1 General

The usage of HTTP custom headers shall be supported as specified in subclause 5.2.3 of 3GPP TS 29.500 [4].

6.5.3 Resources

6.5.3.1 Overview

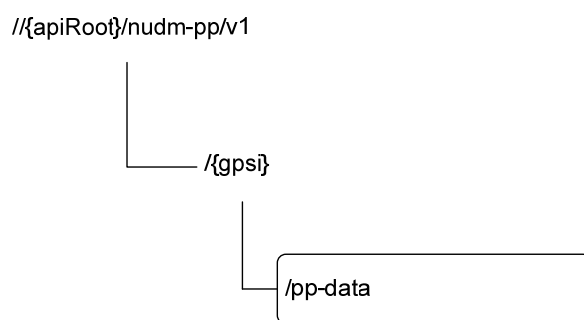

Figure 6.5.3.1-1: Resource URI structure of the Nudm_PP API

Table 6.5.3.1-1 provides an overview of the resources and applicable HTTP methods.

Table 6.5.3.1-1: Resources and methods overview

Resource name	Resource URI	HTTP method or custom operation	Description
PpData	//apiRoot}/nudm-pp/v1/{gpsi}/pp-data	PATCH	Modify the UE's modifiable subscription data

6.5.3.2 Resource: PpData

6.5.3.2.1 Description

This resource is used to represent Parameter Provisioning Data.

6.5.3.2.2 Resource Definition

Resource URI: {apiRoot}/nudm-pp/v1/{gpsi}/pp-data

This resource shall support the resource URI variables defined in table 6.5.3.2.2-1.

Table 6.5.3.2.2-1: Resource URI variables for this resource

Name	Definition
apiRoot	See subclause 6.5.1
gpsi	Represents the Generic Public Subscription Identifier (see 3GPP TS 23.501 [2] subclause 5.9.8) pattern: "(msisdn-[0-9]{5,15} ext-id-.[@.+.+)")"

6.5.3.2.3 Resource Standard Methods

6.5.3.2.3.1 PATCH

This method shall support the URI query parameters specified in table 6.5.3.2.3.1-1.

Table 6.5.3.2.3.1-1: URI query parameters supported by the PATCH method on this resource

Name	Data type	P	Cardinality	Description
n/a				

This method shall support the request data structures specified in table 6.5.3.2.3.1-2 and the response data structures and response codes specified in table 6.5.3.2.3.1-3.

Table 6.5.3.2.3.1-2: Data structures supported by the PATCH Request Body on this resource

Data type	P	Cardinality	Description
PpData	M	1	The AMF registration for non 3GPP access is modified with the received information.

Table 6.2.3.3.2-3: Data structures supported by the PATCH Response Body on this resource

Data type	P	Cardinality	Response codes	Description
n/a			204 No Content	Upon success, an empty response body shall be returned
NOTE: In addition common data structures as listed in table 6.2.7-1 are supported.				

6.5.4 Custom Operations without associated resources

In this release of this specification, no custom operations without associated resources are defined for the Nudm_ParameterProvision Service.

6.5.5 Notifications

In this release of this specification, no notifications are defined for the Nudm_ParameterProvision Service.

6.5.6 Data Model

6.5.6.1 General

This subclause specifies the application data model supported by the API.

Editor's Note: It is ffs which data types should be specified in 3GPP TS 29.571.

Table 6.5.6.1-1 specifies the data types defined for the Nudm_PP service API.

Table 6.5.6.1-1: Nudm_PP specific Data Types

Data type	Section defined	Description
PpData	6.5.6.2.2	Parameter Provision Data
CommunicationCharacteristics	6.5.6.2.3	Communication Characteristics
PpSubsRegTimer	6.5.6.2.4	
PpActiveTime	6.5.6.2.5	

Table 6.5.6.1-2 specifies data types re-used by the Nudm_PP service API from other APIs, including a reference and when needed, a short description of their use within the Nudm_PP service API.

Table 6.5.6.1-2: Nudm_PP re-used Data Types

Data type	Reference	Comments
DurationSec	3GPP TS 29.571 [7]	Time value in seconds
SupportedFeatures	3GPP TS 29.571 [7]	
NfInstanceId	3GPP TS 29.571 [7]	
ProblemDetails	3GPP TS 29.571 [7]	
Gpsi	3GPP TS 29.571 [7]	

6.5.6.2 Structured data types

6.5.6.2.1 Introduction

This subclause defines the structures to be used in resource representations.

Allowed structures are: array, object.

6.5.6.2.2 Type: PpData

Table 6.5.6.2.2-1: Definition of type PpData

Attribute name	Data type	P	Cardinality	Description
supportedFeatures	SupportedFeatures	O	0..1	
communicationCharacteristics	CommunicationCharacteristics	O	0..1	communication characteristics

6.5.6.2.3 Type: CommunicationCharacteristics

Table 6.5.6.2.3-1: Definition of type CommunicationCharacteristics

Attribute name	Data type	P	Cardinality	Description
ppSubsRegTimer	PpSubsRegTimer	O	0..1	AF provisionedSubscribed periodic registration timer; nullable
ppActiveTime	PpActiveTime	O	0..1	AF provisioned active time; nullable
ppDIPacketCount	PpDIPacketCount	O	0..1	AF provisioned DL Buffering Suggested Packet Count; nullable

6.5.6.2.4 Type: PpSubsRegTimer

Table 6.5.6.2.4-1: Definition of type PpSubsRegTimer

Attribute name	Data type	P	Cardinality	Description
subsRegTimer	DurationSec	M	1	value in seconds
afId	NfInstanceId	M	1	Id of the originating AF
referenceId	ReferenceId	M	1	Transaction Reference ID

6.5.6.2.5 Type: PpActiveTime

Table 6.5.6.2.5-1: Definition of type PpActiveTime

Attribute name	Data type	P	Cardinality	Description
activeTime	DurationSec	M	1	value in seconds
afld	NfInstanceld	M	1	Id of the originating AF
referenceld	Referenceld	M	1	Transaction Reference ID

6.5.6.3 Simple data types and enumerations

6.5.6.3.1 Introduction

This subclause defines simple data types and enumerations that can be referenced from data structures defined in the previous subclauses.

6.5.6.3.2 Simple data types

The simple data types defined in table 6.5.6.3.2-1 shall be supported.

Table 6.5.6.3.2-1: Simple data types

Type Name	Type Definition	Description
Referenceld	integer	
PpDIPacketCount	integer	nullable

6.5.6.3.3 Enumeration: <EnumType1>

Table 6.5.6.3.3-1: Enumeration <EnumType1>

Enumeration value	Description

6.5.7 Error Handling

This subclause will include a reference to the general error handling principles specified in TS 29.501, and further specify any general error handling aspect specific to the API, if any Error handling specific to each method (and resource) is specified in subclauses 6.4.3. and 6.4.4.

Editor's Note: A subclause 6.5.8 Feature Negotiation may be further added to describe the mechanism to provide feature extensibility depending on the extensibility mechanisms that will be agreed for the 5GC SBIs.

6.5.8 Security

As indicated in 3GPP TS 33.501 [6], the access to the Nudm_PP API shall be authorized by means of the OAuth2 protocol (see IETF RFC 6749 [18]), using the "Client Credentials" authorization grant, where the NRF (see 3GPP TS 29.510 [19]) plays the role of the authorization server.

An NF Service Consumer, prior to consuming services offered by the Nudm_PP API, shall obtain a "token" from the authorization server, by invoking the Access Token Request service, as described in 3GPP TS 29.510 [19], subclause 5.8.2.2.

NOTE: When multiple NRFs are deployed in a network, the NRF used as authorization server is the same NRF that the NF Service Consumer used for discovering the Nudm_PP service.

The Nudm_PP API does not define any scopes for OAuth2 authorization.

Annex A (normative): OpenAPI specification

A.1 General

This Annex specifies the formal definition of the Nudm Service API(s). It consists of OpenAPI 3.0.0 specifications, in YAML format.

A.2 Nudm_SDM API

```

openapi: 3.0.0

info:
  version: '1.PreR15.0.0'
  title: 'Nudm_SDM'
  description: 'Nudm Subscriber Data Management Service'

servers:
  - url: https://{apiRoot}/nudm-sdm/v1
    variables:
      apiRoot:
        default: https://demohost.com
        description: apiRoot as defined in subclause subclause 4.4 of 3GPP TS 29.501, excluding the
        https:// part.

security:
  - oAuth2ClientCredentials: []

paths:
  /{supi}:
    get:
      summary: retrieve multiple data sets
      operationId: Get
      tags:
        - Retrieval of multiple data sets
      parameters:
        - name: supi
          in: path
          description: Identifier of the UE
          required: true
          schema:
            $ref: 'TS29571_CommonData.yaml#/components/schemas/Supi'
        - name: dataset-names
          in: query
          description: List of dataset names
          required: true
          schema:
            $ref: '#/components/schemas/DatasetNames'
        - name: plmn-id
          in: query
          description: serving PLMN ID
          content:
            application/json:
              schema:
                $ref: 'TS29571_CommonData.yaml#/components/schemas/PlmnId'
        - name: supportedFeatures
          in: query
          description: Supported Features
          schema:
            $ref: 'TS29571_CommonData.yaml#/components/schemas/SupportedFeatures'
      responses:
        '200':
          description: Expected response to a valid request
          content:
            application/json:
              schema:
                $ref: '#/components/schemas/SubscriptionDataSets'
        '404':
          description: User (SUPI) does not exist
          default:
            description: Unexpected error

```

```

    content:
      application/problem+json:
        schema:
          $ref: 'TS29571_CommonData.yaml#/components/schemas/ProblemDetails'
/{supi}/nssai:
  get:
    summary: retrieve a UE's subscribed NSSAI
    operationId: Get
    tags:
      - Subscribed Network Slice Selection Assistance Information Retrieval
    parameters:
      - name: supi
        in: path
        description: Identifier of the UE
        required: true
        schema:
          $ref: 'TS29571_CommonData.yaml#/components/schemas/Supi'
      - name: supportedFeatures
        in: query
        description: Supported Features
        schema:
          $ref: 'TS29571_CommonData.yaml#/components/schemas/SupportedFeatures'
      - name: plmn-id
        in: query
        description: serving PLMN ID
        content:
          application/json:
            schema:
              $ref: 'TS29571_CommonData.yaml#/components/schemas/PlmnId'
    responses:
      '200':
        description: Expected response to a valid request
        content:
          application/json:
            schema:
              $ref: '#/components/schemas/Nssai'
      '404':
        description: User (SUPI) does not exist
    default:
      description: Unexpected error
      content:
        application/problem+json:
          schema:
            $ref: 'TS29571_CommonData.yaml#/components/schemas/ProblemDetails'
/{supi}/am-data:
  get:
    summary: retrieve a UE's Access and Mobility Subscription Data
    operationId: Get
    tags:
      - Access and Mobility Subscription Data Retrieval
    parameters:
      - name: supi
        in: path
        description: Identifier of the UE
        required: true
        schema:
          $ref: 'TS29571_CommonData.yaml#/components/schemas/Supi'
      - name: supportedFeatures
        in: query
        description: Supported Features
        schema:
          $ref: 'TS29571_CommonData.yaml#/components/schemas/SupportedFeatures'
      - name: plmn-id
        in: query
        description: serving PLMN ID
        content:
          application/json:
            schema:
              $ref: 'TS29571_CommonData.yaml#/components/schemas/PlmnId'
    responses:
      '200':
        description: Expected response to a valid request
        content:
          application/json:
            schema:
              $ref: '#/components/schemas/AccessAndMobilitySubscriptionData'
      '404':
        description: User (SUPI) does not exist

```

```

    default:
      description: Unexpected error
      content:
        application/problem+json:
          schema:
            $ref: 'TS29571_CommonData.yaml#/components/schemas/ProblemDetails'
  /{supi}/smf-select-data:
    get:
      summary: retrieve a UE's SMF Selection Subscription Data
      operationId: Get
      tags:
        - SMF Selection Subscription Data Retrieval
      parameters:
        - name: supi
          in: path
          description: Identifier of the UE
          required: true
          schema:
            $ref: 'TS29571_CommonData.yaml#/components/schemas/Supi'
        - name: supportedFeatures
          in: query
          description: Supported Features
          schema:
            $ref: 'TS29571_CommonData.yaml#/components/schemas/SupportedFeatures'
        - name: plmn-id
          in: query
          description: serving PLMN ID
          content:
            application/json:
              schema:
                $ref: 'TS29571_CommonData.yaml#/components/schemas/PlmnId'
      responses:
        '200':
          description: Expected response to a valid request
          content:
            application/json:
              schema:
                $ref: '#/components/schemas/SmfSelectionSubscriptionData'
        '404':
          description: User (SUPI) does not exist
      default:
        description: Unexpected error
        content:
          application/problem+json:
            schema:
              $ref: 'TS29571_CommonData.yaml#/components/schemas/ProblemDetails'
  /{supi}/ue-context-in-smf-data:
    get:
      summary: retrieve a UE's UE Context In SMF Data
      operationId: Get
      tags:
        - UE Context In SMF Data Retrieval
      parameters:
        - name: supi
          in: path
          description: Identifier of the UE
          required: true
          schema:
            $ref: 'TS29571_CommonData.yaml#/components/schemas/Supi'
        - name: supportedFeatures
          in: query
          description: Supported Features
          schema:
            $ref: 'TS29571_CommonData.yaml#/components/schemas/SupportedFeatures'
      responses:
        '200':
          description: Expected response to a valid request
          content:
            application/json:
              schema:
                $ref: '#/components/schemas/UeContextInSmfData'
        '404':
          description: User (SUPI) does not exist
      default:
        description: Unexpected error
        content:
          application/problem+json:
            schema:

```

```

    $ref: 'TS29571_CommonData.yaml#/components/schemas/ProblemDetails'
  /{supi}/sm-data:
    get:
      summary: retrieve a UE's Session Management Subscription Data
      operationId: Get
      tags:
        - Session Management Subscription Data Retrieval
      parameters:
        - name: supi
          in: path
          description: Identifier of the UE
          required: true
          schema:
            $ref: 'TS29571_CommonData.yaml#/components/schemas/Supi'
        - name: supportedFeatures
          in: query
          description: Supported Features
          schema:
            $ref: 'TS29571_CommonData.yaml#/components/schemas/SupportedFeatures'
        - name: singleNssai
          in: query
          content:
            application/json:
              schema:
                $ref: 'TS29571_CommonData.yaml#/components/schemas/Snssai'
        - name: dnn
          in: query
          schema:
            $ref: 'TS29571_CommonData.yaml#/components/schemas/Dnn'
        - name: plmnId
          in: query
          content:
            application/json:
              schema:
                $ref: 'TS29571_CommonData.yaml#/components/schemas/PlmnId'
      responses:
        '200':
          description: Expected response to a valid request
          content:
            application/json:
              schema:
                type: array
                items:
                  $ref: '#/components/schemas/SessionManagementSubscriptionData'
                minItems: 1
        '404':
          description: User (SUPI) does not exist
      default:
        description: Unexpected error
        content:
          application/problem+json:
            schema:
              $ref: 'TS29571_CommonData.yaml#/components/schemas/ProblemDetails'
  /{supi}/sms-data:
    get:
      summary: retrieve a UE's SMS Subscription Data
      operationId: Get
      tags:
        - SMS Subscription Data Retrieval
      parameters:
        - name: supi
          in: path
          description: Identifier of the UE
          required: true
          schema:
            $ref: 'TS29571_CommonData.yaml#/components/schemas/Supi'
        - name: supportedFeatures
          in: query
          description: Supported Features
          schema:
            $ref: 'TS29571_CommonData.yaml#/components/schemas/SupportedFeatures'
        - name: plmnId
          in: query
          content:
            application/json:
              schema:
                $ref: 'TS29571_CommonData.yaml#/components/schemas/PlmnId'
      responses:

```

```

'200':
  description: Expected response to a valid request
  content:
    application/json:
      schema:
        $ref: '#/components/schemas/SmsSubscriptionData'
'404':
  description: User (SUPI) does not exist
default:
  description: Unexpected error
  content:
    application/problem+json:
      schema:
        $ref: 'TS29571_CommonData.yaml#/components/schemas/ProblemDetails'
/{supi}/sms-mng-data:
  get:
    summary: retrieve a UE's SMS Management Subscription Data
    operationId: Get
    tags:
      - SMS Management Subscription Data Retrieval
    parameters:
      - name: supi
        in: path
        description: Identifier of the UE
        required: true
        schema:
          $ref: 'TS29571_CommonData.yaml#/components/schemas/Supi'
      - name: supportedFeatures
        in: query
        description: Supported Features
        schema:
          $ref: 'TS29571_CommonData.yaml#/components/schemas/SupportedFeatures'
      - name: plmnId
        in: query
        content:
          application/json:
            schema:
              $ref: 'TS29571_CommonData.yaml#/components/schemas/PlmnId'
    responses:
      '200':
        description: Expected response to a valid request
        content:
          application/json:
            schema:
              $ref: '#/components/schemas/SmsManagementSubscriptionData'
      '404':
        description: User (SUPI) does not exist
    default:
      description: Unexpected error
      content:
        application/problem+json:
          schema:
            $ref: 'TS29571_CommonData.yaml#/components/schemas/ProblemDetails'
/{supi}/sdm-subscriptions:
  post:
    summary: subscribe to notifications
    operationId: Subscribe
    tags:
      - Subscription Creation
    parameters:
      - name: supi
        in: path
        description: SUPI of the user
        required: true
        schema:
          $ref: 'TS29571_CommonData.yaml#/components/schemas/Supi'
    requestBody:
      content:
        application/json:
          schema:
            $ref: '#/components/schemas/SdmSubscription'
      required: true
    responses:
      '201':
        description: Expected response to a valid request
        content:
          application/json:
            schema:

```

```

        $ref: '#/components/schemas/SdmSubscription'
    '404':
        description: User (SUPI) does not exist
    default:
        description: Unexpected error
        content:
            application/problem+json:
                schema:
                    $ref: 'TS29571_CommonData.yaml#/components/schemas/ProblemDetails'
    callbacks:
        datachangeNotification:
            '{request.body#/callbackReference}':
                post:
                    requestBody:
                        required: true
                        content:
                            application/json:
                                schema:
                                    $ref: '#/components/schemas/ModificationNotification'
                    responses:
                        '204':
                            description: Successful Notification response
/{supi}/sdm-subscriptions/{subscriptionId}:
    delete:
        summary: unsubscribe from notifications
        operationId: Unsubscribe
        tags:
            - Subscription Deletion
        parameters:
            - name: supi
              in: path
              description: SUPI of the user
              required: true
              schema:
                  $ref: 'TS29571_CommonData.yaml#/components/schemas/Supi'
            - name: subscriptionId
              in: path
              description: Id of the SDM Subscription
              required: true
              schema:
                  type: string
        responses:
            '204':
                description: Successful response
/{gpsi}/id-translation-result:
    get:
        summary: retrieve a UE's SUPI
        operationId: Get
        tags:
            - GPSI to SUPI Translation
        parameters:
            - name: gpsi
              in: path
              description: Identifier of the UE
              required: true
              schema:
                  $ref: 'TS29571_CommonData.yaml#/components/schemas/Gpsi'
            - name: supportedFeatures
              in: query
              description: Supported Features
              schema:
                  $ref: 'TS29571_CommonData.yaml#/components/schemas/SupportedFeatures'
        responses:
            '200':
                description: Expected response to a valid request
                content:
                    application/json:
                        schema:
                            $ref: '#/components/schemas/IdTranslationResult'
            '404':
                description: User (GPSI) does not exist
    default:
        description: Unexpected error
        content:
            application/problem+json:
                schema:
                    $ref: 'TS29571_CommonData.yaml#/components/schemas/ProblemDetails'

```

```

components:
  securitySchemes:
    oAuth2ClientCredentials:
      type: oauth2
      flows:
        clientCredentials:
          tokenUrl: '{nrfApiRoot}/oauth2/token'
          scopes: {}

  schemas:

# COMPLEX TYPES:

DatasetNames:
  type: array
  items:
    $ref: '#/components/schemas/DataSetName'
  minItems: 2
  uniqueItems: true

SubscriptionDataSets:
  type: object
  properties:
    amData:
      $ref: '#/components/schemas/AccessAndMobilitySubscriptionData'
    smfSelData:
      $ref: '#/components/schemas/SmfSelectionSubscriptionData'

AccessAndMobilitySubscriptionData:
  type: object
  properties:
    supportedFeatures:
      $ref: 'TS29571_CommonData.yaml#/components/schemas/SupportedFeatures'
    gpsis:
      type: array
      items:
        $ref: 'TS29571_CommonData.yaml#/components/schemas/Gpsi'
    internalGroupIds:
      type: array
      items:
        $ref: '#/components/schemas/InternalGroupId'
    subscribedUeAmbr:
      $ref: 'TS29571_CommonData.yaml#/components/schemas/Ambr'
    nssai:
      $ref: '#/components/schemas/Nssai'
    ratRestrictions:
      type: array
      items:
        $ref: 'TS29571_CommonData.yaml#/components/schemas/RatType'
    areaRestrictions:
      type: array
      items:
        $ref: '#/components/schemas/AreaRestriction'
    coreNetworkTypeRestrictions:
      type: array
      items:
        $ref: '#/components/schemas/CoreNetworkType'
    rfspIndex:
      $ref: 'TS29571_CommonData.yaml#/components/schemas/RfspIndex'
    subsRegTimer:
      $ref: 'TS29571_CommonData.yaml#/components/schemas/DurationSec'
    ueUsageType:
      $ref: '#/components/schemas/UeUsageType'
    ladnInformation:
      type: array
      items:
        $ref: 'TS29571_CommonData.yaml#/components/schemas/Dnn'
    mpsPriority:
      $ref: '#/components/schemas/MpsPriorityIndicator'
    activeTime:
      $ref: 'TS29571_CommonData.yaml#/components/schemas/DurationSec'
    dlPacketCount:
      $ref: '#/components/schemas/DlPacketCount'

AreaRestriction:
  type: object
  required:

```

```

    - restrictionType
  properties:
    restrictionType:
      $ref: '#/components/schemas/RestrictionType'
    areaInformation:
      $ref: '#/components/schemas/AreaInformation'
    ratTypes:
      type: array
      items:
        $ref: 'TS29571_CommonData.yaml#/components/schemas/RatType'

AreaInformation:
  type: object
  properties:
    tacs:
      type: array
      items:
        $ref: 'TS29571_CommonData.yaml#/components/schemas/Tac'
    areaCodes:
      type: array
      items:
        $ref: '#/components/schemas/AreaCode'
    maxNumderTAs:
      type: integer

SmfSelectionSubscriptionData:
  type: object
  properties:
    supportedFeatures:
      $ref: 'TS29571_CommonData.yaml#/components/schemas/SupportedFeatures'
    subscribedSnssaiInfo:
      type: array
      items:
        $ref: '#/components/schemas/SnssaiInfo'

SnssaiInfo:
  type: object
  required:
    - singleNssai
    - dnnInfos
  properties:
    singleNssai:
      $ref: 'TS29571_CommonData.yaml#/components/schemas/Snssai'
    dnnInfos:
      type: array
      items:
        $ref: '#/components/schemas/DnnInfo'
    minItems: 1

DnnInfo:
  type: object
  required:
    - dnn
  properties:
    dnn:
      $ref: 'TS29571_CommonData.yaml#/components/schemas/Dnn'
    defaultDnnIndicator:
      $ref: '#/components/schemas/DnnIndicator'
    lboRoamingAllowed:
      $ref: '#/components/schemas/LboRoamingAllowed'

Nssai:
  type: object
  properties:
    supportedFeatures:
      $ref: 'TS29571_CommonData.yaml#/components/schemas/SupportedFeatures'
    defaultSingleNssais:
      type: array
      items:
        $ref: 'TS29571_CommonData.yaml#/components/schemas/Snssai'
      maxItems: 8
    singleNssais:
      type: array
      items:
        $ref: 'TS29571_CommonData.yaml#/components/schemas/Snssai'

UeContextInSmfData:
  type: object

```



```

    additionalProperties:
      $ref: '#/components/schemas/PduSession'
    minProperties: 1

PduSession:
  type: object
  required:
    - pduSessionId
    - dnn
    - smfId
    - smfAddress
  properties:
    pduSessionId:
      $ref: 'TS29571_CommonData.yaml#/components/schemas/PduSessionId'
    dnn:
      $ref: 'TS29571_CommonData.yaml#/components/schemas/Dnn'
    smfId:
      $ref: 'TS29571_CommonData.yaml#/components/schemas/NfInstanceId'
    smfAddress:
      $ref: '#/components/schemas/IpAddress'

SessionManagementSubscriptionData:
  type: object
  required:
    - singleNssai
  properties:
    singleNssai:
      $ref: 'TS29571_CommonData.yaml#/components/schemas/Snssai'
    dnnConfiguration:
      type: object
      additionalProperties:
        $ref: '#/components/schemas/DnnConfiguration'

DnnConfiguration:
  type: object
  required:
    - dnn
    - pduSessionTypes
    - sscModes
  properties:
    dnn:
      $ref: 'TS29571_CommonData.yaml#/components/schemas/Dnn'
    pduSessionTypes:
      $ref: '#/components/schemas/PduSessionTypes'
    sscModes:
      $ref: '#/components/schemas/ScsModes'
    ldnIndicator:
      $ref: '#/components/schemas/LdnIndicator'
    5gQosProfile:
      $ref: '#/components/schemas/5GQosProfile'
    sessionAmbr:
      $ref: 'TS29571_CommonData.yaml#/components/schemas/Ambr'
    3gppChargingCharacteristics:
      $ref: '#/components/schemas/3GppChargingCharacteristics'
    staticIpAddress:
      $ref: '#/components/schemas/IpAddress'

IpAddress:
  type: object
  properties:
    ipv4Addr:
      $ref: 'TS29571_CommonData.yaml#/components/schemas/Ipv4Addr'
    ipv6Addr:
      $ref: 'TS29571_CommonData.yaml#/components/schemas/Ipv6Addr'
    ipv6Prefix:
      $ref: 'TS29571_CommonData.yaml#/components/schemas/Ipv6Prefix'

PduSessionTypes:
  type: object
  required:
    - defaultSessionType
  properties:
    defaultSessionType:
      $ref: 'TS29571_CommonData.yaml#/components/schemas/PduSessionType'
    allowedSessionTypes:
      type: array
      items:
        $ref: 'TS29571_CommonData.yaml#/components/schemas/PduSessionType'

```

```

SscModes:
  type: object
  required:
    - defaultSscMode
  properties:
    defaultSscMode:
      $ref: 'TS29571_CommonData.yaml#/components/schemas/SscMode'
    allowedSscModes:
      type: array
      items:
        $ref: 'TS29571_CommonData.yaml#/components/schemas/SscMode'
      minItems: 0
      maxItems: 2

5GQosProfile:
  type: object
  required:
    - 5qi
  properties:
    5qi:
      $ref: 'TS29571_CommonData.yaml#/components/schemas/5qi'
    arp:
      $ref: 'TS29571_CommonData.yaml#/components/schemas/Arp'

SmsSubscriptionData:
  type: object
  properties:
    smsSupported:
      $ref: '#/components/schemas/SmsSupport'

SmsManagementSubscriptionData:
  type: object
  required:
    - mtSmsSubscribed
    - moSmsSubscribed
  properties:
    supportedFeatures:
      $ref: 'TS29571_CommonData.yaml#/components/schemas/SupportedFeatures'
    mtSmsSubscribed:
      type: boolean
    mtSmsBarringAll:
      type: boolean
    mtSmsBarringRoaming:
      type: boolean
    moSmsSubscribed:
      type: boolean
    moSmsBarringAll:
      type: boolean
    moSmsBarringRoaming:
      type: boolean

SdmSubscription:
  type: object
  required:
    - callbackUri
    - monitoredResourceUri
  properties:
    callbackReference:
      $ref: 'TS29571_CommonData.yaml#/components/schemas/Uri'
    monitoredResourceUris:
      type: array
      items:
        $ref: 'TS29571_CommonData.yaml#/components/schemas/Uri'
      minItems: 1

ModificationNotification:
  type: object
  properties:
    amDataModification:
      $ref: '#/components/schemas/AccessAndMobilitySubscriptionData'
    smfSelDataModification:
      $ref: '#/components/schemas/SmfSelectionSubscriptionData'
    smsMngDataModification:
      $ref: '#/components/schemas/SmsManagementSubscriptionData'
    smDataModification:
      $ref: '#/components/schemas/SessionManagementSubscriptionData'

```

```
IdTranslationResult:
  type: object
  required:
  - supi
  properties:
    supportedFeatures:
      $ref: 'TS29571_CommonData.yaml#/components/schemas/SupportedFeatures'
    supi:
      $ref: 'TS29571_CommonData.yaml#/components/schemas/Supi'
    gpsi:
      $ref: 'TS29571_CommonData.yaml#/components/schemas/Gpsi'

# SIMPLE TYPES:

UeUsageType:
  type: integer

MpsPriorityIndicator:
  type: boolean

DnnIndicator:
  type: boolean

LboRoamingAllowed:
  type: boolean

LadnIndicator:
  type: boolean

SmsSupport:
  type: boolean

3GppChargingCharacteristics:
  type: string

DlPacketCount:
  type: integer
  minimum: -1

InternalGroupId:
  type: string

AreaCode:
  type: string

# ENUMS:

DataSetName:
  anyOf:
  - type: string
  enum:
  - AM
  - SMF_SEL
  - type: string

RestrictionType:
  anyOf:
  - type: string
  enum:
  - SAR_ALLOWED_AREA
  - SAR_NOT_ALLOWED_AREA
  - FORBIDDEN_AREA
  - type: string

CoreNetworkType:
  anyOf:
  - type: string
  enum:
  - 5GC
  - EPC
  - type: string

externalDocs:
  description: Documentation
  url: 'http://www.3gpp.org/ftp/Specs/archive/29_series/29.503/'
```

A.3 Nudm_UECM API

openapi: 3.0.0

```

info:
  version: '1.PreR15.0.0'
  title: 'Nudm_UECM'
  description: 'Nudm Context Management Service'

servers:
  - url: https://{apiRoot}/nudm-uecm/v1
    variables:
      apiRoot:
        default: https://demohost.com
        description: apiRoot as defined in subclause subclause 4.4 of 3GPP TS 29.501, excluding the
https:// part.

security:
  - oAuth2ClientCredentials: []

paths:
  /{ueId}/registrations/amf-3gpp-access:
    put:
      summary: register as AMF for 3GPP access
      operationId: Registration
      tags:
        - AMF registration for 3GPP access
      parameters:
        - name: ueId
          in: path
          description: Identifier of the UE
          required: true
          schema:
            $ref: 'TS29571_CommonData.yaml#/components/schemas/Supi'
      requestBody:
        content:
          application/json:
            schema:
              $ref: '#/components/schemas/Amf3GppAccessRegistration'
            required: true
      responses:
        '204':
          description: Expected response to a valid request
        '404':
          description: User (SUPI) does not exist
        default:
          description: Unexpected error
          content:
            application/problem+json:
              schema:
                $ref: 'TS29571_CommonData.yaml#/components/schemas/ProblemDetails'
      callbacks:
        deregistrationNotification:
          '{request.body#/deregCallbackUri}':
            post:
              requestBody:
                required: true
                content:
                  application/json:
                    schema:
                      $ref: '#/components/schemas/DeregistrationData'
              responses:
                '204':
                  description: Successful Notification response
    patch:
      summary: Update a parameter in the AMF registration for 3GPP access
      operationId: Update
      tags:
        - Parameter update in the AMF registration for 3GPP access
      parameters:
        - name: ueId
          in: path
          description: Identifier of the UE
          required: true
          schema:
            $ref: 'TS29571_CommonData.yaml#/components/schemas/Supi'
      requestBody:

```

```

    content:
      application/merge-patch+json:
        schema:
          $ref: '#/components/schemas/Amf3GppAccessRegistrationModification'
    required: true
  responses:
    '204':
      description: Expected response to a valid request
    '404':
      description: User (SUPI) does not exist
  default:
    description: Unexpected error
    content:
      application/problem+json:
        schema:
          $ref: 'TS29571_CommonData.yaml#/components/schemas/ProblemDetails'
get:
  summary: retrieve the AMF registration for 3GPP access information
  operationId: Get
  tags:
    - AMF 3Gpp-access Registration Info Retrieval
  parameters:
    - name: ueId
      in: path
      description: Identifier of the UE
      required: true
      schema:
        $ref: 'TS29571_CommonData.yaml#/components/schemas/Gpsi'
    - name: supportedFeatures
      in: query
      schema:
        $ref: 'TS29571_CommonData.yaml#/components/schemas/SupportedFeatures'
  responses:
    '200':
      description: Expected response to a valid request
      content:
        application/json:
          schema:
            $ref: '#/components/schemas/Amf3GppAccessRegistration'
    '404':
      description: User (GPSI) does not exist
  default:
    description: Unexpected error
    content:
      application/problem+json:
        schema:
          $ref: 'TS29571_CommonData.yaml#/components/schemas/ProblemDetails'
/{ueId}/registrations/amf-non-3gpp-access:
  put:
    summary: register as AMF for non-3GPP access
    operationId: Register
    tags:
      - AMF registration for non-3GPP access
    parameters:
      - name: ueId
        in: path
        description: Identifier of the UE
        required: true
        schema:
          $ref: 'TS29571_CommonData.yaml#/components/schemas/Supi'
    requestBody:
      content:
        application/json:
          schema:
            $ref: '#/components/schemas/AmfNon3GppAccessRegistration'
      required: true
    responses:
      '204':
        description: Expected response to a valid request
      '404':
        description: User (SUPI) does not exist
    default:
      description: Unexpected error
      content:
        application/problem+json:
          schema:
            $ref: 'TS29571_CommonData.yaml#/components/schemas/ProblemDetails'

```

```

callbacks:
  deregistrationNotification:
    '{request.body#/deregCallbackUri}':
      post:
        requestBody:
          required: true
          content:
            application/json:
              schema:
                $ref: '#/components/schemas/DeregistrationData'
        responses:
          '204':
            description: Successful Notification response
patch:
  summary: update a parameter in the AMF registration for non-3GPP access
  operationId: Update
  tags:
    - Parameter update in the AMF registration for non-3GPP access
  parameters:
    - name: ueId
      in: path
      description: Identifier of the UE
      required: true
      schema:
        $ref: 'TS29571_CommonData.yaml#/components/schemas/Supi'
  requestBody:
    content:
      application/merge-patch+json:
        schema:
          $ref: '#/components/schemas/AmfNon3GppAccessRegistrationModification'
    required: true
  responses:
    '204':
      description: Expected response to a valid request
    '404':
      description: User (SUPI) does not exist
    default:
      description: Unexpected error
      content:
        application/problem+json:
          schema:
            $ref: 'TS29571_CommonData.yaml#/components/schemas/ProblemDetails'
get:
  summary: retrieve the AMF registration for non-3GPP access information
  operationId: Get
  tags:
    - AMF non-3GPP-access Registration Info Retrieval
  parameters:
    - name: ueId
      in: path
      description: Identifier of the UE
      required: true
      schema:
        $ref: 'TS29571_CommonData.yaml#/components/schemas/Gpsi'
    - name: supportedFeatures
      in: query
      schema:
        $ref: 'TS29571_CommonData.yaml#/components/schemas/SupportedFeatures'
  responses:
    '200':
      description: Expected response to a valid request
      content:
        application/json:
          schema:
            $ref: '#/components/schemas/AmfNon3GppAccessRegistration'
    '404':
      description: User (GPSI) does not exist
    default:
      description: Unexpected error
      content:
        application/problem+json:
          schema:
            $ref: 'TS29571_CommonData.yaml#/components/schemas/ProblemDetails'
/{ueId}/registrations/smf-registrations/{pduSessionId}:
  put:
    summary: register as SMF
    operationId: Registration

```

```

tags:
- SMF Registration
parameters:
- name: ueId
  in: path
  description: Identifier of the UE
  required: true
  schema:
    $ref: 'TS29571_CommonData.yaml#/components/schemas/Supi'
- name: pduSessionId
  in: path
  description: Identifier of the PDU session
  required: true
  schema:
    $ref: 'TS29571_CommonData.yaml#/components/schemas/PduSessionId'
requestBody:
  content:
    application/json:
      schema:
        $ref: '#/components/schemas/SmfRegistration'
  required: true
responses:
'200':
  description: Expected response to a valid request
  content:
    application/json:
      schema:
        $ref: '#/components/schemas/SmfRegistration'
'404':
  description: User (SUPI) does not exist
default:
  description: Unexpected error
  content:
    application/problem+json:
      schema:
        $ref: 'TS29571_CommonData.yaml#/components/schemas/ProblemDetails'
callbacks:
  pcscfRestorationNotification:
    '{request.body#/pcscfRestorationCallbackUri}':
      post:
        requestBody:
          required: true
          content:
            application/json:
              schema:
                $ref: '#/components/schemas/PcscfRestorationNotification'
        responses:
          '204':
            description: Successful Notification response
delete:
  summary: delete an SMF registration
  operationId: Deregistration
  tags:
  - SMF Deregistration
  parameters:
  - name: ueId
    in: path
    description: Identifier of the UE
    required: true
    schema:
      $ref: 'TS29571_CommonData.yaml#/components/schemas/Supi'
  - name: pduSessionId
    in: path
    description: Identifier of the PDU session
    required: true
    schema:
      $ref: 'TS29571_CommonData.yaml#/components/schemas/PduSessionId'
  responses:
  '204':
    description: Expected response to a valid request
  '404':
    description: User (SUPI) does not exist
  default:
    description: Unexpected error
    content:
      application/problem+json:
        schema:
          $ref: 'TS29571_CommonData.yaml#/components/schemas/ProblemDetails'

```

```
/{ueId}/registrations/smsf-3gpp-access:
  put:
    summary: register as SMSF for 3GPP access
    operationId: Update SMSF Reg 3GPP
    tags:
      - SMSF registration for 3GPP access
    parameters:
      - name: ueId
        in: path
        description: Identifier of the UE
        required: true
        schema:
          $ref: 'TS29571_CommonData.yaml#/components/schemas/Supi'
    requestBody:
      content:
        application/json:
          schema:
            $ref: '#/components/schemas/SmsfRegistration'
      required: true
    responses:
      '204':
        description: Expected response to a valid request
      '404':
        description: User (SUPI) does not exist
      default:
        description: Unexpected error
        content:
          application/problem+json:
            schema:
              $ref: 'TS29571_CommonData.yaml#/components/schemas/ProblemDetails'
  delete:
    summary: delete the SMSF registration for 3GPP access
    operationId: Deregistration
    tags:
      - SMSF Deregistration for 3GPP Access
    parameters:
      - name: ueId
        in: path
        description: Identifier of the UE
        required: true
        schema:
          $ref: 'TS29571_CommonData.yaml#/components/schemas/Supi'
    responses:
      '204':
        description: Expected response to a valid request
      '404':
        description: User (SUPI) does not exist
      default:
        description: Unexpected error
        content:
          application/problem+json:
            schema:
              $ref: 'TS29571_CommonData.yaml#/components/schemas/ProblemDetails'
  get:
    summary: retrieve the SMSF registration for 3GPP access information
    operationId: Get
    tags:
      - SMSF 3GPP access Registration Info Retrieval
    parameters:
      - name: ueId
        in: path
        description: Identifier of the UE
        required: true
        schema:
          $ref: 'TS29571_CommonData.yaml#/components/schemas/Gpsi'
      - name: supportedFeatures
        in: query
        schema:
          $ref: 'TS29571_CommonData.yaml#/components/schemas/SupportedFeatures'
    responses:
      '200':
        description: Expected response to a valid request
        content:
          application/json:
            schema:
              $ref: '#/components/schemas/SmsfRegistration'
      '404':
```



```

    description: User (GPSI) does not exist
  default:
    description: Unexpected error
    content:
      application/problem+json:
        schema:
          $ref: 'TS29571_CommonData.yaml#/components/schemas/ProblemDetails'

/{ueId}/registrations/smsf-non-3gpp-access:
  put:
    summary: register as SMSF for non-3GPP access
    operationId: Registration
    tags:
      - SMSF registration for non-3GPP access
    parameters:
      - name: ueId
        in: path
        description: Identifier of the UE
        required: true
        schema:
          $ref: 'TS29571_CommonData.yaml#/components/schemas/Supi'
    requestBody:
      content:
        application/json:
          schema:
            $ref: '#/components/schemas/SmsfRegistration'
      required: true
    responses:
      '204':
        description: Expected response to a valid request
      '404':
        description: User (SUPI) does not exist
    default:
      description: Unexpected error
      content:
        application/problem+json:
          schema:
            $ref: 'TS29571_CommonData.yaml#/components/schemas/ProblemDetails'

delete:
  summary: delete SMSF registration for non 3GPP access
  operationId: Deregistration
  tags:
    - SMSF Deregistration for non-3GPP access
  parameters:
    - name: ueId
      in: path
      description: Identifier of the UE
      required: true
      schema:
        $ref: 'TS29571_CommonData.yaml#/components/schemas/Supi'
  responses:
    '204':
      description: Expected response to a valid request
    '404':
      description: User (SUPI) does not exist
  default:
    description: Unexpected error
    content:
      application/problem+json:
        schema:
          $ref: 'TS29571_CommonData.yaml#/components/schemas/ProblemDetails'

get:
  summary: retrieve the SMSF registration for non-3GPP access information
  operationId: Get
  tags:
    - SMSF non-3GPP access Registration Info Retrieval
  parameters:
    - name: ueId
      in: path
      description: Identifier of the UE
      required: true
      schema:
        $ref: 'TS29571_CommonData.yaml#/components/schemas/Gpsi'
    - name: supportedFeatures
      in: query
      schema:
        $ref: 'TS29571_CommonData.yaml#/components/schemas/SupportedFeatures'
  responses:

```

```

'200':
  description: Expected response to a valid request
  content:
    application/json:
      schema:
        $ref: '#/components/schemas/SmsfRegistration'
'404':
  description: User (GPSI) does not exist
default:
  description: Unexpected error
  content:
    application/problem+json:
      schema:
        $ref: 'TS29571_CommonData.yaml#/components/schemas/ProblemDetails'

components:
  securitySchemes:
    oAuth2ClientCredentials:
      type: oauth2
      flows:
        clientCredentials:
          tokenUrl: '{nrfApiRoot}/oauth2/token'
          scopes: {}

  schemas:

# COMPLEX TYPES:

Amf3GppAccessRegistration:
  type: object
  required:
    - amfId
    - deregCallbackUri
  properties:
    amfId:
      $ref: 'TS29571_CommonData.yaml#/components/schemas/NfInstanceId'
    supportedFeatures:
      $ref: 'TS29571_CommonData.yaml#/components/schemas/SupportedFeatures'
    purgeFlag:
      $ref: '#/components/schemas/PurgeFlag'
    pei:
      $ref: 'TS29571_CommonData.yaml#/components/schemas/Pei'
    imsVoPS:
      $ref: '#/components/schemas/ImsVoPS'
    deregCallbackUri:
      $ref: 'TS29571_CommonData.yaml#/components/schemas/Uri'
    pcscfRestorationCallbackUri:
      $ref: 'TS29571_CommonData.yaml#/components/schemas/Uri'

Amf3GppAccessRegistrationModification:
  type: object
  properties:
    purgeFlag:
      $ref: '#/components/schemas/PurgeFlag'
    pei:
      $ref: 'TS29571_CommonData.yaml#/components/schemas/Pei'
    imsVoPS:
      $ref: '#/components/schemas/ImsVoPS'

AmfNon3GppAccessRegistration:
  type: object
  required:
    - amfId
    - deregCallbackUri
  properties:
    amfId:
      $ref: 'TS29571_CommonData.yaml#/components/schemas/NfInstanceId'
    supportedFeatures:
      $ref: 'TS29571_CommonData.yaml#/components/schemas/SupportedFeatures'
    purgeFlag:
      $ref: '#/components/schemas/PurgeFlag'
    pei:
      $ref: 'TS29571_CommonData.yaml#/components/schemas/Pei'
    deregCallbackUri:
      $ref: 'TS29571_CommonData.yaml#/components/schemas/Uri'
    pcscfRestorationCallbackUri:
      $ref: 'TS29571_CommonData.yaml#/components/schemas/Uri'

```

```
AmfNon3GppAccessRegistrationModification:
  type: object
  properties:
    purgeFlag:
      $ref: '#/components/schemas/PurgeFlag'
    pei:
      $ref: 'TS29571_CommonData.yaml#/components/schemas/Pei'

SmfRegistration:
  type: object
  required:
    - smfId
    - pduSessionId
    - dnn
  properties:
    smfId:
      $ref: 'TS29571_CommonData.yaml#/components/schemas/NfInstanceId'
    supportedFeatures:
      $ref: 'TS29571_CommonData.yaml#/components/schemas/SupportedFeatures'
    pduSessionId:
      $ref: 'TS29571_CommonData.yaml#/components/schemas/PduSessionId'
    dnn:
      $ref: 'TS29571_CommonData.yaml#/components/schemas/Dnn'
    pcscfRestorationCallbackUri:
      $ref: 'TS29571_CommonData.yaml#/components/schemas/Uri'

SmsfRegistration:
  type: object
  required:
    - smsfId
  properties:
    smsfId:
      $ref: 'TS29571_CommonData.yaml#/components/schemas/NfInstanceId'
    supportedFeatures:
      $ref: 'TS29571_CommonData.yaml#/components/schemas/SupportedFeatures'

DeregistrationData:
  type: object
  required:
    - deregReason
  properties:
    deregReason:
      $ref: '#/components/schemas/DeregistrationReason'

PcscfRestorationNotification:
  type: object
  required:
    - supi
  properties:
    supi:
      $ref: 'TS29571_CommonData.yaml#/components/schemas/Supi'

# SIMPLE TYPES:

PurgeFlag:
  type: boolean

# ENUMS:

ImsVoPS:
  anyOf:
    - type: string
      enum:
        - HOMOGENEOUS_SUPPORT
        - HOMOGENEOUS_NON_SUPPORT
        - NON_HOMOGENEOUS_OR_UNKNOWN
    - type: string

DeregistrationReason:
  anyOf:
    - type: string
      enum:
        - UE_INITIAL_REGISTRATION
        - UE_REGISTRATION_AREA_CHANGE
        - SUBSCRIPTION_WITHDRAWN
        - 5GS_TO_EPS_MOBILITY
    - type: string
```

```
externalDocs:
  description: Documentation
  url: 'http://www.3gpp.org/ftp/Specs/archive/29_series/29.503/'
```

A.4 Nudm_UEAU API

```
openapi: 3.0.0
info:
  version: '1.PreR15.0.0'
  title: 'UDM UE Authenticon'
  description: 'UDM UE Authentication Service'
security:
  - oAuth2ClientCredentials: []
paths:
  /{supiOrSuci}/security-information/generate-auth-data:
    post:
      summary: Generate authentication data for the UE
      operationId: GenerateAuthData
      tags:
        - Generate Auth Data
      parameters:
        - name: supiOrSuci
          in: path
          description: SUPI or SUCI of the user
          required: true
          schema:
            $ref: '#/components/schemas/SupiOrSuci'
      requestBody:
        content:
          application/json:
            schema:
              $ref: '#/components/schemas/AuthenticationInfoRequest'
            required: true
      responses:
        '200':
          description: Expected response to a valid request
          content:
            application/json:
              schema:
                $ref: '#/components/schemas/AuthenticationInfoResult'
        '404':
          description: User (SUPI or SUCI) does not exist
          content:
            application/problem+json:
              schema:
                $ref: 'TS29571_CommonData.yaml#/components/schemas/ProblemDetails'
        default:
          description: Unexpected error
          content:
            application/problem+json:
              schema:
                $ref: 'TS29571_CommonData.yaml#/components/schemas/ProblemDetails'

  /{supi}/auth-events:
    post:
      summary: Create a new confirmation event
      operationId: ConfirmAuth
      tags:
        - Confirm Auth
      parameters:
        - name: supi
          in: path
          description: SUPI of the user
          required: true
          schema:
            $ref: 'TS29571_CommonData.yaml#/components/schemas/Supi'
      requestBody:
        content:
          application/json:
            schema:
              $ref: '#/components/schemas/AuthEvent'
            required: true
      responses:
        '201':
          description: Expected response to a valid request
          content:
            application/json:
```

```

    schema:
      $ref: '#/components/schemas/AuthEvent'
  '404':
    description: User (SUPI) does not exist
    content:
      application/problem+json:
        schema:
          $ref: 'TS29571_CommonData.yaml#/components/schemas/ProblemDetails'
  default:
    description: Unexpected error
    content:
      application/problem+json:
        schema:
          $ref: 'TS29571_CommonData.yaml#/components/schemas/ProblemDetails'

components:
  securitySchemes:
    oAuth2ClientCredentials:
      type: oauth2
      flows:
        clientCredentials:
          tokenUrl: '{nrfApiRoot}/oauth2/token'
          scopes: {}

  schemas:

# COMPLEX TYPES:

AuthenticationInfoRequest:
  type: object
  required:
    - servingNetworkName
  properties:
    supportedFeatures:
      $ref: 'TS29571_CommonData.yaml#/components/schemas/SupportedFeatures'
    servingNetworkName:
      $ref: '#/components/schemas/ServingNetworkName'
    resynchronizationInfo:
      $ref: '#/components/schemas/ResynchronizationInfo'

AuthenticationInfoResult:
  type: object

  properties:
    supportedFeatures:
      $ref: 'TS29571_CommonData.yaml#/components/schemas/SupportedFeatures'
    authenticationVector:
      $ref: '#/components/schemas/AuthenticationVector'
    supi:
      $ref: 'TS29571_CommonData.yaml#/components/schemas/Supi'

AuthenticationVector:
  oneOf:
    - $ref: '#/components/schemas/AvEapAkaPrime'
    - $ref: '#/components/schemas/Av5GHeAka'
  discriminator:
    propertyName: avType
  mapping:
    5G_HE_AKA: '#/components/schemas/Av5GHeAka'
    EAP_AKA_PRIME: '#/components/schemas/AvEapAkaPrime'

AvEapAkaPrime:
  type: object
  required:
    - avType
    - rand
    - xres
    - autn
    - ckPrime
    - ikPrime
  properties:
    avType:
      $ref: '#/components/schemas/AvType'
    rand:
      $ref: '#/components/schemas/Rand'
    xres:
      $ref: '#/components/schemas/Xres'
    autn:

```

```

    $ref: '#/components/schemas/Autn'
  ckPrime:
    $ref: '#/components/schemas/CkPrime'
  ikPrime:
    $ref: '#/components/schemas/IkPrime'

```

```

Av5GHeAka:
  type: object
  required:
    - avType
    - rand
    - xresStar
    - autn
    - kausf
  properties:
    avType:
      $ref: '#/components/schemas/AvType'
    rand:
      $ref: '#/components/schemas/Rand'
    xresStar:
      $ref: '#/components/schemas/XresStar'
    autn:
      $ref: '#/components/schemas/Autn'
    kausf:
      $ref: '#/components/schemas/Kausf'

```

```

ResynchronizationInfo:
  type: object
  required:
    - rand
    - auts
  properties:
    rand:
      $ref: '#/components/schemas/Rand'
    auts:
      $ref: '#/components/schemas/Auts'

```

```

AuthEvent:
  type: object
  required:
    - nfInstanceId
    - success
    - timeStamp
    - authType
  properties:
    nfInstanceId:
      $ref: 'TS29571_CommonData.yaml#/components/schemas/NfInstanceId'
    success:
      $ref: '#/components/schemas/Success'
    timeStamp:
      $ref: 'TS29571_CommonData.yaml#/components/schemas/DateTime'
    authType:
      $ref: '#/components/schemas/AuthType'

```

SIMPLE TYPES:

```

Autn:
  type: string
  pattern: "[A-Fa-f0-9]{32}$"

Auts:
  type: string
  pattern: "[A-Fa-f0-9]{28}$"

CkPrime:
  type: string
  pattern: "[A-Fa-f0-9]{32}$"

IkPrime:
  type: string
  pattern: "[A-Fa-f0-9]{32}$"

Kausf:
  type: string
  pattern: "[A-Fa-f0-9]{64}$"

Rand:
  type: string

```

```

    pattern: "[A-Za-f0-9]{32}$"

Xres:
  type: string
  pattern: "[A-Za-f0-9]{8,32}$"

XresStar:
  type: string
  pattern: "[A-Za-f0-9]{32}$"

SupiOrSuci:
  type: string
  pattern: "^(imsi-[0-9]{5,15}|nai-.+|suci-[0-9]{5,6}-[0-9]{1,4}-[a-fA-F0-9]-(NULL|[a-zA-Z0-9]+)-[a-fA-F0-9]+|.+) $"

ServingNetworkName:
  type: string
  pattern: "^5G:mnc[0-9]{3}[.]mcc[0-9]{3}[.]3gppnetwork[.]org$"

Success:
  type: boolean

# ENUMS:

AuthType:
  anyOf:
    - type: string
      enum:
        - 5G_AKA
        - EAP_AKA_PRIME
        - EAP_TLS
    - type: string

AvType:
  anyOf:
    - type: string
      enum:
        - 5G_HE_AKA
        - EAP_AKA_PRIME
    - type: string

externalDocs:
  description: Documentation
  url: 'http://www.3gpp.org/ftp/Specs/archive/29_series/29.503/'

```

A.5 Nudm_EE API

openapi: 3.0.0

```

info:
  version: '1.PreR15.0.0'
  title: 'Nudm_EE'
  description: 'Nudm Event Exposure Service'

```

```

servers:
  - url: https://{apiRoot}/nudm-ee/v1
    variables:
      apiRoot:
        default: https://demohost.com
        description: apiRoot as defined in subclause subclause 4.4 of 3GPP TS 29.501, excluding the
https:// part.

```

```

security:
  - oAuth2ClientCredentials: []

```

```

paths:
  /{gpsi}/ee-subscriptions:
    post:
      summary: Subscribe
      operationId: CreateEeSubscription
      tags:
        - Create EE Subscription
      parameters:
        - name: gpsi
          in: path

```

```

    description: GPSI of the user
    required: true
    schema:
      $ref: 'TS29571_CommonData.yaml#/components/schemas/Gpsi'
  requestBody:
    content:
      application/json:
        schema:
          $ref: '#/components/schemas/EeSubscription'
    required: true
  responses:
    '201':
      description: Expected response to a valid request
      content:
        application/json:
          schema:
            $ref: '#/components/schemas/EeSubscription'
    '404':
      description: User (GPSI) does not exist
  default:
    description: Unexpected error
    content:
      application/problem+json:
        schema:
          $ref: 'TS29571_CommonData.yaml#/components/schemas/ProblemDetails'
  callbacks:
    eventOccurrenceNotification:
      '{request.body#/callbackReference}':
        post:
          requestBody:
            required: true
            content:
              application/json:
                schema:
                  $ref: '#/components/schemas/MonitoringReport'
          responses:
            '204':
              description: Successful Notification response

/{gpsi}/ee-subscriptions/{subscriptionId}:
  delete:
    summary: Unsubscribe
    operationId: DeleteEeSubscription
    tags:
      - Delete EE Subscription
    parameters:
      - name: gpsi
        in: path
        description: GPSI of the user
        required: true
        schema:
          $ref: 'TS29571_CommonData.yaml#/components/schemas/Gpsi'
      - name: subscriptionId
        in: path
        description: Id of the EE Subscription
        required: true
        schema:
          type: string
    responses:
      '204':
        description: Successful response

components:
  securitySchemes:
    oAuth2ClientCredentials:
      type: oauth2
      flows:
        clientCredentials:
          tokenUrl: '{nrfApiRoot}/oauth2/token'
          scopes: {}

schemas:

# COMPLEX TYPES:

EeSubscription:
  type: object
  required:

```



```

- callbackReference
- monitoringConfiguration
properties:
  callbackReference:
    $ref: 'TS29571_CommonData.yaml#/components/schemas/Uri'
  monitoringConfiguration:
    description : A map (list of key-value pairs where ReferenceId serves as key) of
MonitoringConfigurations
    type: object
    additionalProperties:
      $ref: '#/components/schemas/MonitoringConfiguration'
    minProperties: 1
    supportedFeatures:
      $ref: 'TS29571_CommonData.yaml#/components/schemas/SupportedFeatures'

MonitoringConfiguration:
  type: object
  required:
    - referencId
    - eventType
    - reportingOptions
  properties:
    referenceId:
      $ref: '#/components/schemas/ReferenceId'
    eventType:
      $ref: '#/components/schemas/EventType'
    reportingOptions:
      $ref: '#/components/schemas/ReportingOptions'

ReportingOptions:
  type: object
  properties:
    maxNumOfReports:
      $ref: '#/components/schemas/MaxNumOfReports'
    monitoringDuration:
      $ref: 'TS29571_CommonData.yaml#/components/schemas/DateTime'

MonitoringReport:
  type: object
  required:
    - referencId
    - eventType
  properties:
    referenceId:
      $ref: '#/components/schemas/ReferenceId'
    eventType:
      $ref: '#/components/schemas/EventType'
    report:
      $ref: '#/components/schemas/Report'

Report:
  oneOf:
    - $ref: '#/components/schemas/ChangeOfSupiPeiAssociationReport'
    - $ref: '#/components/schemas/RoamingStatusReport'

ChangeOfSupiPeiAssociationReport:
  type: object
  required:
    - newPei
  properties:
    newPei:
      $ref: 'TS29571_CommonData.yaml#/components/schemas/Pei'

RoamingStatusReport:
  type: object
  required:
    - roaming
    - newServingPlmn
  properties:
    roaming:
      type:
        boolean
    newServingPlmn:
      $ref: 'TS29571_CommonData.yaml#/components/schemas/PlmnId'

```

SIMPLE TYPES:

ReferenceId:

```
type: integer
```

```
MaxNumOfReports:  
type: integer
```

```
# ENUMS:
```

```
EventType:  
anyOf:  
- type: string  
  enum:  
  - LOSS_OF_CONNECTIVITY  
  - UE_REACHABILITY_FOR_DATA  
  - UE_REACHABILITY_FOR_SMS  
  - LOCATION_REPORTING  
  - CHANGE_OF_SUPI_PEI_ASSOCIATION  
  - ROAMING_STATUS  
  - COMMUNICATION_FAILURE  
  - AVAILABILITY_AFTER_DNN_FAILURE  
- type: string
```

```
externalDocs:  
description: Documentation  
url: 'http://www.3gpp.org/ftp/Specs/archive/29_series/29.503/'
```

A.6 Nudm_PP API

```

openapi: 3.0.0

info:
  version: '1.PreR15.0.0'
  title: 'Nudm_PP'
  description: 'Nudm Parameter Provision Service'

servers:
  - url: https://{apiRoot}/nudm-pp/v1
    variables:
      apiRoot:
        default: https://demohost.com
        description: apiRoot as defined in subclause subclause 4.4 of 3GPP TS 29.501, excluding the
https:// part.

security:
  - oAuth2ClientCredentials: []

paths:
  /{gpsi}/pp-data:
    patch:
      summary: provision parameters
      operationId: Update
      tags:
        - Subscription Data Update
      parameters:
        - name: gpsi
          in: path
          description: Identifier of the UE
          required: true
          schema:
            $ref: 'TS29571_CommonData.yaml#/components/schemas/Gpsi'
      requestBody:
        content:
          application/merge-patch+json:
            schema:
              $ref: '#/components/schemas/PpData'
        required: true
      responses:
        '204':
          description: Expected response to a valid request
        '404':
          description: User (GPSI) does not exist
        default:
          description: Unexpected error
          content:
            application/problem+json:
              schema:
                $ref: 'TS29571_CommonData.yaml#/components/schemas/ProblemDetails'

components:
  securitySchemes:
    oAuth2ClientCredentials:
      type: oauth2
      flows:
        clientCredentials:
          tokenUrl: '{nrfApiRoot}/oauth2/token'
          scopes: {}

schemas:

# COMPLEX TYPES:

PpData:
  type: object
  properties:
    communicationCharacteristics:
      $ref: '#/components/schemas/CommunicationCharacteristics'
    supportedFeatures:
      $ref: 'TS29571_CommonData.yaml#/components/schemas/SupportedFeatures'

```

```

CommunicationCharacteristics:
  type: object
  properties:
    ppSubsRegTimer:
      $ref: '#/components/schemas/PpSubsRegTimer'
    ppActiveTime:
      $ref: '#/components/schemas/PpActiveTime'
    ppDlPacketCount:
      $ref: '#/components/schemas/PpDlPacketCount'

PpSubsRegTimer:
  type: object
  required:
    - subsRegTimer
    - afId
    - referenceId
  properties:
    subsRegTimer:
      $ref: 'TS29571_CommonData.yaml#/components/schemas/DurationSec'
    afId:
      $ref: 'TS29571_CommonData.yaml#/components/schemas/NfInstanceId'
    referenceId:
      $ref: '#/components/schemas/ReferenceId'
  nullable: true

PpActiveTime:
  type: object
  required:
    - activeTime
    - afId
    - referenceId
  properties:
    activeTime:
      $ref: 'TS29571_CommonData.yaml#/components/schemas/DurationSec'
    afId:
      $ref: 'TS29571_CommonData.yaml#/components/schemas/NfInstanceId'
    referenceId:
      $ref: '#/components/schemas/ReferenceId'
  nullable: true

# SIMPLE TYPES:

ReferenceId:
  type: integer

PpDlPacketCount:
  type: integer
  nullable: true

# ENUMS:

externalDocs:
  description: Documentation
  url: 'http://www.3gpp.org/ftp/Specs/archive/29_series/29.503/'

```

Annex B (informative): Stateless UDMs

Figure B-1 shows a scenario where the stateless UDM receives and processes a request from an NF.

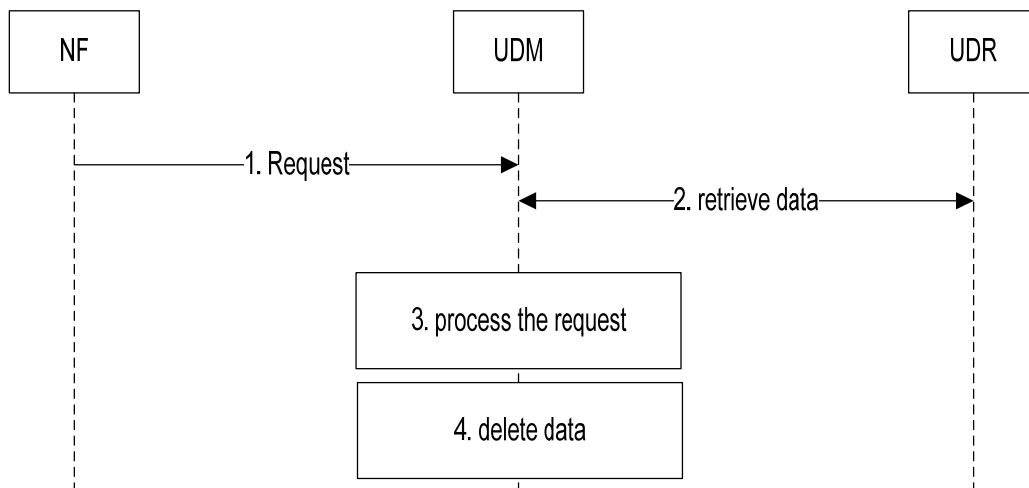

Figure B-1: Stateless UDM

1. The stateless UDM receives a request from an NF. This can be a request to perform an Nudm service, or a Notification that the UDM has previously subscribed to at the NF by means of a service the UDM consumes from the NF. In the later case the NF can be the UDR.
2. The UDM retrieves data from the UDR that are required to process the request. This step can be skipped if the request was a notification from the UDR and contained enough information so that the UDM can process the request.
3. The UDM processes the received request. This can include consuming services from other NFs, consuming services from the UDR (e.g. to update data or subscribe to notifications), and sending notifications to NFs that have subscribed at the UDM to receive notifications, and includes sending the response to the NF (all not shown in the figure).
4. The UDM locally deletes the data retrieved in step 2 and/or received in step 1.

Figure B-2 shows a scenario where an AMF subscribes to notifications of data change (permanent provisioned subscription data) at the stateless UDM. The UDM (UDM 1) stores the subscription to notification in the UE's context data at the UDR.

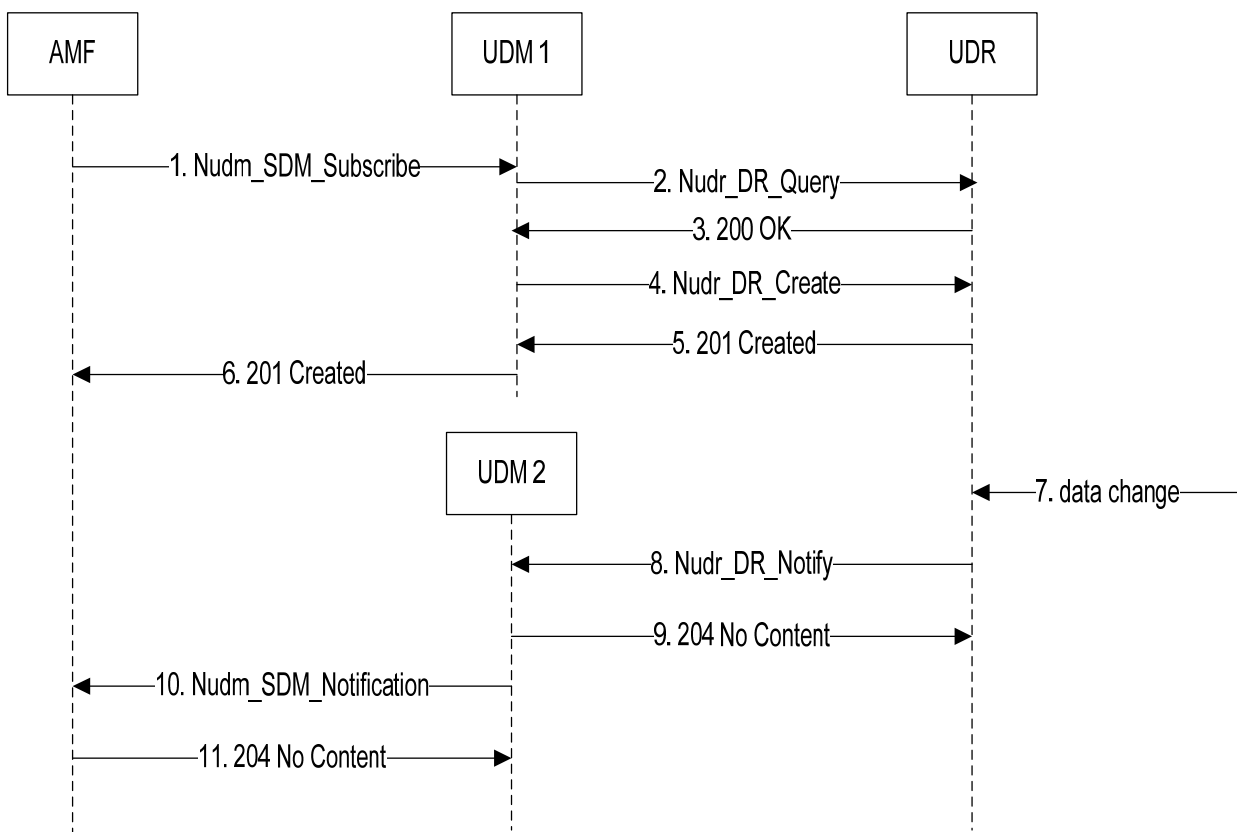

Figure B-2: Subscription to notification

1. The stateless UDM 1 receives a subscribe request from an AMF; see clause 5.2.2.3.2.
- 2.-3 The UDM retrieves UE context data from the UDR to be able to perform required plausibility checks; see 3GPP TS 29.504 [9] clause 5.2.2.2.2.
4. The UDM creates a new sdm subscription at the UDR; see 3GPP TS 29.504 [9] clause 5.2.2.3.3.
5. The UDR sends a 201 Created response containing a subscription ID
6. The UDM send a 201 Created response passing the subscription ID received in step 5 to the AMF.
7. Permanent provisioned Subscription data are modified at the UDR.
8. The UDR selects a suitable UDM and sends a Notification; see 3GPP TS 29.504 [9] clause 5.2.2.8. In addition to the data that have changed, the Notification request message can contain enough (unchanged) information (e.g. the information that has been created in step 4) allowing the UDM to perform step 10 without the need to additionally retrieve information from the UDR.
9. The UDM responds with 204 No Content.
10. The UDM notifies the AMF according to the callback URI of the AMF contained in the Notification received in step 8; see clause 5.2.2.5.2.
11. The AMF responds with 204 No Content.

Annex C (informative): Change history

Change history							
Date	Meeting	TDoc	CR	Rev	Cat	Subject/Comment	New version
2017-10	CT4#80	C4-175320				TS skeleton	0.1.0
2017-10	CT4#80	C4-175362				Implementation of pCRs agreed at CT4#80.	0.2.0
2017-12	CT4#81	C4-176150 C4-176153 C4-176423 C4-176365 C4-176424 C4-176425				Implementation of pCRs agreed at CT4#81	0.3.0
2018-01	CT4#82	C4-181277 C4-181278 C4-181239 C4-181241 C4-181245 C4-181280 C4-181282 C4-181131 C4-181247 C4-181284 C4-181250 C4-181273 C4-181252 C4-181254				Implementation of pCRs agreed at CT4#82	0.4.0
2018-03	CT4#83	C4-182178 C4-182270 C4-182354 C4-182352 C4-182274 C4-182400 C4-182402 C4-182356 C4-182351 C4-182401 C4-182268				Implementation of pCRs agreed at CT4#83	0.5.0
2018-04	CT4#84	C4-183124 C4-183143 C4-183221 C4-183225 C4-183228 C4-183230 C4-183232 C4-183234 C4-183244 C4-183300 C4-183302 C4-183304 C4-183305 C4-183306 C4-183307 C4-183308 C4-183374 C4-183381 C4-183382 C4-183425 C4-183427 C4-183430 C4-183480 C4-183483 C4-183486 C4-183508 C4-183509				Implementation of pCRs agreed at CT4#84	0.6.0

2018-05					"yaml files" added into the zip-file	0.6.1
2018-05	CT4#85	C4-184351 C4-184356 C4-184210 C4-184211 C4-184358 C4-184359 C4-184558 C4-184559 C4-184381 C4-184556 C4-184423 C4-184557 C4-184310 C4-184572 C4-184622			Implementation of pCRs agreed at CT4#85	0.7.0
2018-06	CT#80	CP-181001			Presented for information and approval.	1.0.0
2018-06	CT#80	CP-181196			Approved in CT#80	15.0.0